

PEDAK DISPLAY

Manual P5 / P7

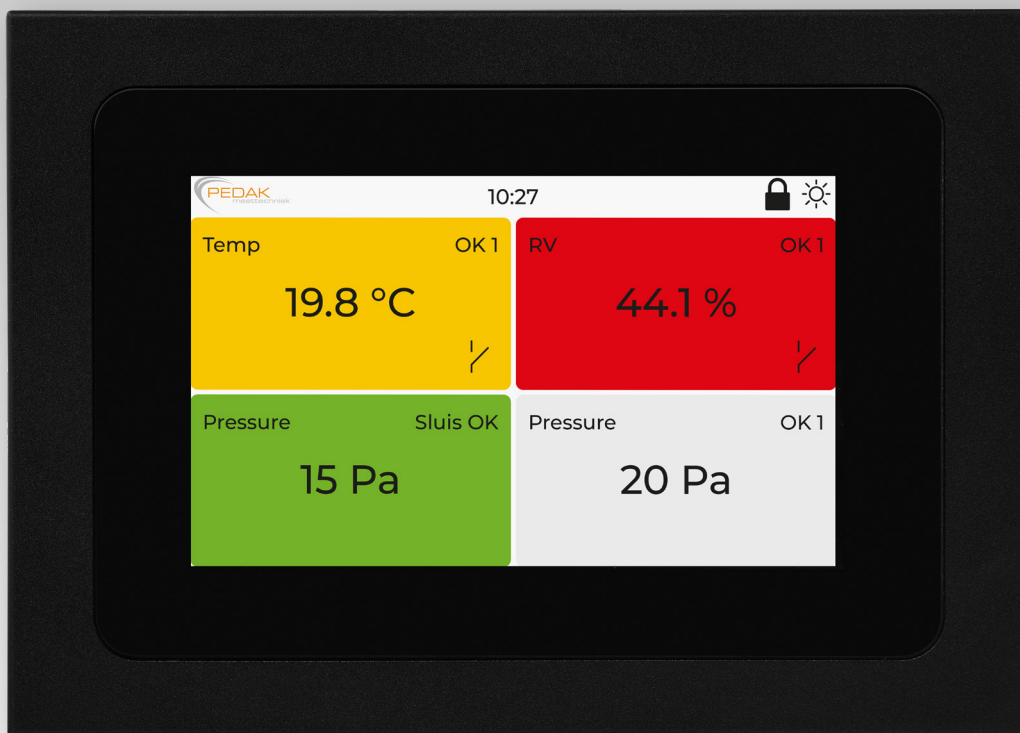

Content:

1.	Basic Requirements and Safety	3
2.	Technical Specifications and Description	4
3.	Mounting Instructions	7
4.	Wiring Diagram	8
5.	Settings	12
5.1.	Main Settings	12
5.2.	Sensor Input	15
-	Modbus TCP Server	15
-	Modbus RS485 Client	16
-	Analog Input	17
-	Digital Input	18
-	nSens Input	19
-	Puzzle IO Input	20
5.3	Field	21
5.4	Save	26
5.5	Back	26
6	Out of use Function	27
7	Day – Night Function	27
8	Download the LogFile via Wifi	28
9	Modbus	30
-	Modbus TCP/IP (Switch - Slave)	30
-	Modbus TCP/IP (Server - Master)	31
-	Modbus RS-485 (Client - Master)	31
-	Modbus Registers	32
-	Modbus Connection	34
10	Default Factory Settings	35
11	Menu Layout	36
12	Screen Layout	37
13	Trouble Shootings	38
14	Expansion Modules	39
15	Ordering Codes	39

Manual revision 31.03.2026

PEDAK-P5/P7

No part of this manual may be reproduced, stored in a retrieval system, or transmitted in any form or by any means for commercial purposes without prior written permission from **PEDAK meettechniek B.V.**®.

Specifications and contents of this manual are subject to change without notice.

Copyright © PEDAK meettechniek BV® - All rights reserved.

1. BASIC REQUIREMENTS AND SAFETY:



The manufacturer is not responsible for any damages caused by inappropriate installation, not maintaining the proper Technical condition and using the unit against its destination.

Installation should be conducted by qualified personal. During installation all available safety requirements should be considered. The fitter is responsible for executing the installation according to this manual, local safety and EMC regulations.

The unit must be properly set-up, according to the application. Incorrect configuration can cause defective operation, which can lead to unit damage or an accident.

If in the case of a defect of unit operation there is a risk of a serious threat to the safety of people or property additional, independent systems and Solutions to prevent such a threat must be used.

The unit uses dangerous voltage that can cause a lethal accident. The unit must be switched off and disconnected from the power supply prior to starting installation of troubleshooting (in case of malfunction).

Neighboring and mating equipment must meet the requirements of appropriate standards and regulations. Concerning safety and be equipped with adequate anti-overvoltage and anti-interference filters.

Do not attempt to disassemble, repair or modify the unit yourself. The unit has no user serviceable parts. Units, in which a defect was stated must be disconnected and submitted for repair at an authorized service center.



In order to minimize fire or electric shock hazard, the unit must be protected against atmospheric precipitation and excessive humidity.

Do not use the unit in areas threatened with excessive shocks, vibrations, dust, humidity, corrosive gasses and oils.

Do not use the unit in explosion hazard areas.

Do not use the unit in areas with significant temperature variations, exposed to condensation or icing

Do not use the unit in areas exposed to direct sunlight.

Make sure that the ambient temperature (e.g. inside the control box) does not exceed the recommended values. In such cases forced cooling of the unit must be considered (e.g. a ventilator)

The unit is designed for operation in a non-industrial environment and must be used in this way.

2. TECHNICAL SPECIFICATIONS:

P5:

Power supply	DC 24V+/- 20%
Power consumption	170mA
Display	5" TFT display with capacitive touch screen
Protection class	Front IP65 / Wiring IP00
Dimensions	171 x 121 x 35 mm
Mounting hole Display	145 x 95 mm
Mounting hole Wall box	156 x 106 mm
Casing type	Panel, snap in
Ambient temperature	-10°C tot +50°C
Humidity	5% till 90% non-condensing
Wiring	Via connectors on the bottom
Interfaces	RS485, CAN-bus, RS232, USB (manufacturer purpose only)
Ethernet	Standard 10/100 Mbit/s (no POE)
SD input	Micro SD, standard PC compatible
GND	Shared with power supply and inputs
Supplied	Display (5"), Wall Box, Cable gland, grommets



P7:

Power supply	DC 24V+/- 20%
Power consumption	200mA
Display	7" TFT display with capacitive touch screen
Protection class	Front IP65 / Wiring IP00
Dimensions	216 x 145 x 35 mm
Mounting hole Display	190 x 120 mm
Mounting hole Wall box	201 x 131 mm
Casing type	Panel, snap in
Ambient temperature	-10°C tot +50°C
Humidity	5% till 90% non-condensing
Wiring	Via connectors on the bottom
Interfaces	RS485, CAN-bus, RS232, USB (manufacturer purpose only)
Ethernet	Standard 10/100 Mbit/s [RJ45] (no POE)
SD input	Micro SD, standard PC compatible
GND	Shared with power supply and inputs
Supplied	Display (7"), Wall Box, Cable gland, grommets



PRIObox:

Power supply Priobox	230VAC (pre assembled with 2,5 m cable with EU connector)
Dimensions Priobox	255 x 180 x 85 mm (excl. cable gland)
Power Supply Unit	Input 230VAC, output 24VDC / 1,5A (internally wired)
Sensor Supply	24VDC (max. 500mA) via terminal strips
Prio-print	DC 24V+/- 20% (internally wired)
Power consumption	170mA
Dimensions Prioprint	170 x 85 x 55 mm
Casing type	DIN Mounting rail
Ambient temperature	-10°C to +50°C
Humidity	5% till 90% non-condensing
Wiring	Via connectors on the top
Interfaces	RS485, Wi-Fi, Bluetooth
N-Bus	4 x N-bus (Novasina nSens)
Analog Inputs	4 x Analog Inputs* galvanically isolated (0-5V; 0-10V; 0-20mA; 4-20mA, selectable via jumper setting)
Digital Inputs	2 x 24VDC PNP Digital Inputs *
Outputs	2 x Relays (NO,NC,COM) - 230VAC – 8A / 24VDC – 8A I/O expansion connector *
Ethernet	Standard 10/100 Mbit/s [RJ45] (no POE)
GND	Shared with power supply, digital inputs and interfaces
Analog GND	Each analog input is galvanically isolated and has its own isolated ground (Prio-print only)



***can be extended up to 8 analogue/digital inputs and/or 8 relays by using Puzzle-modules**

Description:

The display can show up to 8 inputs simultaneously (user selectable).

Each input can independently generate visual and acoustic alarm (user selectable).

In case of an alarm the background color will change from white or green (no alarm) to yellow (pre alarm) or red (alarm) and an acoustic alarm buzzer will sound (if selected).

The buzzer sound can be muted, while the background color remains unchanged.

The display can be used in combination with the **PRIO-box** to connect 4x Analog and/or 2x Digital inputs as well as 4x Novasina (nSens) sensors [without Novasina transmitters].

The PRIO-box also provides 2 relays.

The digital inputs can be used as *door counter* via a 24VDC pulse (if necessary supplied by the unit {max. 0.5A}), alarms can also be configured.

The counter can count upwards and can manually be reset to “Zero”.

The digital input also can be used to display (user defined) text into a specified field in the display. As long as the 24VDC puls is high the text will be displayed.

All settings can be made via the touch screen, However jumpers need to be set on the back to select the proper analog input (mA or V).

The unit can configured to display a status message, by touching the lock symbol and the message “Out of Service” will be displayed.

NOTE: In “Out of Service” status, all alarm will be suppressed !!

By selecting the Toggle function the display can be used to manually activate or deactivate a relay.

It is also possible to connect Modbus signals directly to the display without using the PRIO-box:

- When connected to devices the display will function as a **Modbus-Master**.
- When connected to a TCP/IP network or BMS the display will function as a **Modbus-Slave**.

Measured data can automatically be saved on the SD-card and can be downloaded via Wifi (in combination with the PRIObox only).

By touching a specific input field the graphics of the measured data of this field will be displayed.

The display can be used in a horizontal (landscape) or vertical (portrait) position (user selectable).

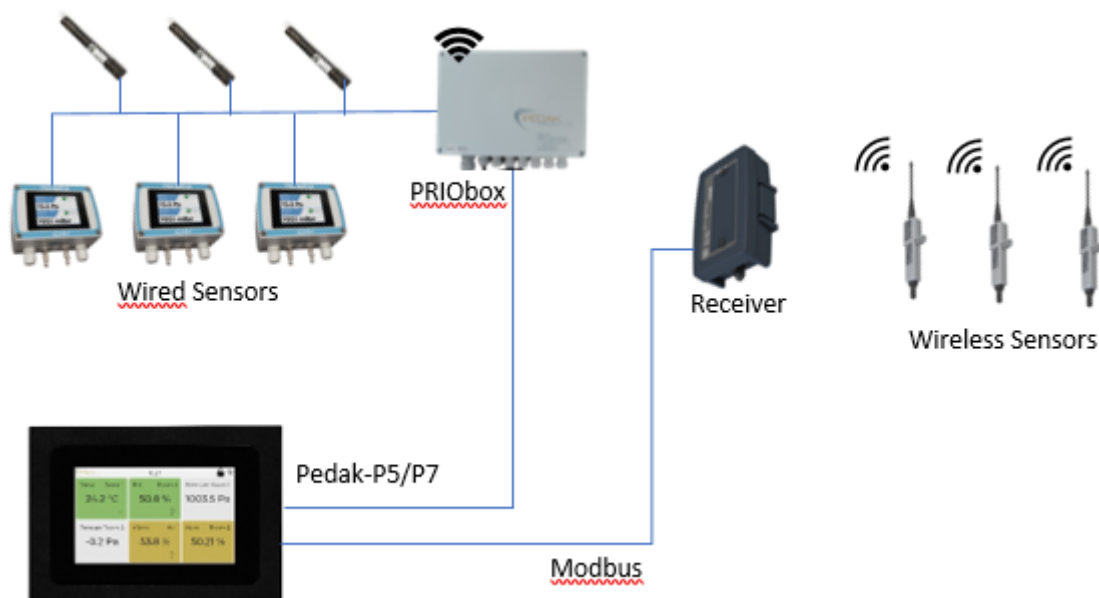

3. MOUNTING INSTRUCTIONS:

Mount the required number of cable glands/grommets in the desired positions in the mounting frame by removing the round metal parts.

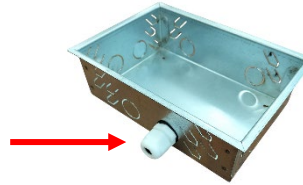

Cut out the required opening in the wall according specified dimensions
(Wall box P5: 156 x 106 mm / Wall box P7: 201 x 131 mm).



Display can be configured to a Horizontal (landscape) or Vertical (portrait) orientation !



Ensure the mounting frame is mounted level !

Slide the mounting frame in the wall opening and bend the clips to the secure it in place.

Insert the display in the mounting frame, the spring clips will prevent the display from falling out.

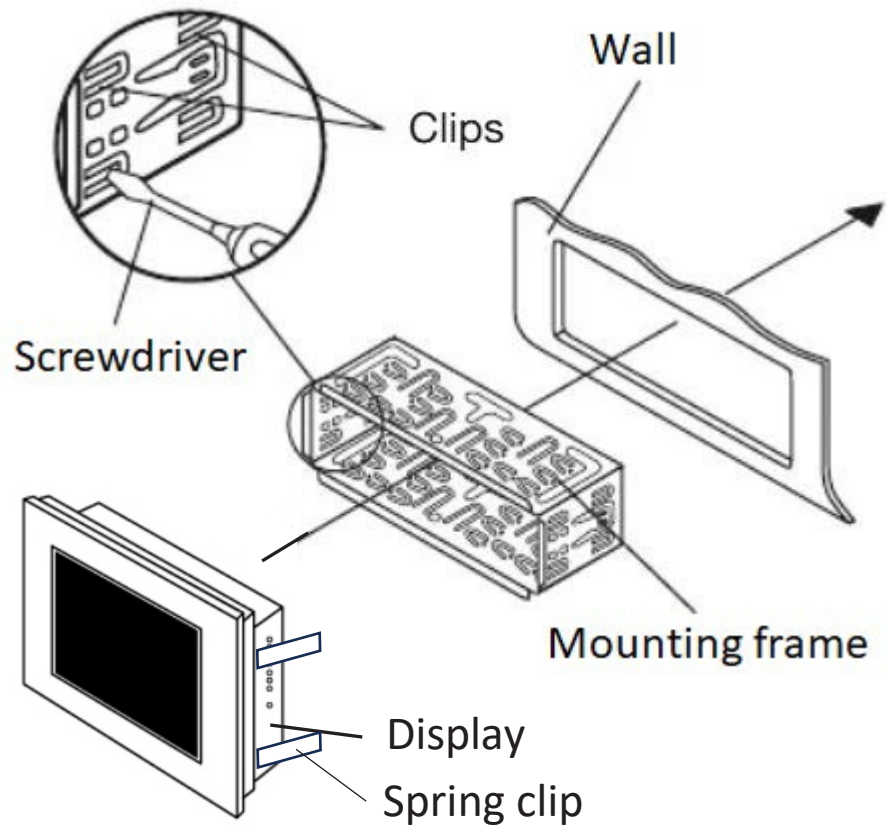

4. WIRE DIAGRAM:

PRIObox

Open the lid from the PRIObox by unscrewing the 4 screws at each corner.

Mount the PRIObox at the desired location via the 4 mounting holes (A).

Insert the sensor cables through the cable glands and connect the sensor(s), relay output, RJ45 cable and power supply for the display (P5/P7) to the designated (screw) terminals on the Prio print.

Power supply for the sensors can be taken from the 24VDC terminal trips (max. 500mA) if needed.

Close the Lid and tighten the 4 screws at each corner.

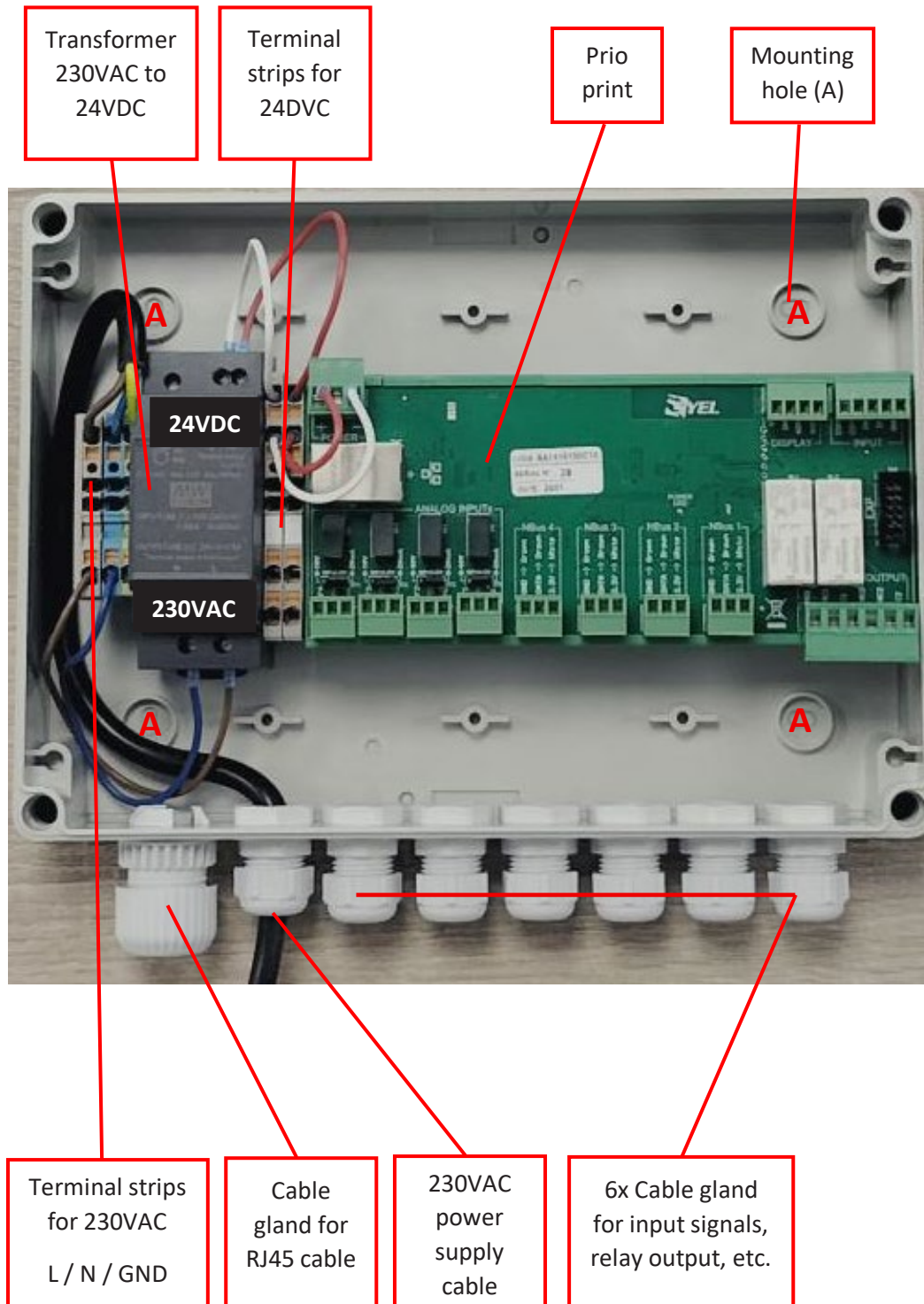

P5/P7 Display:

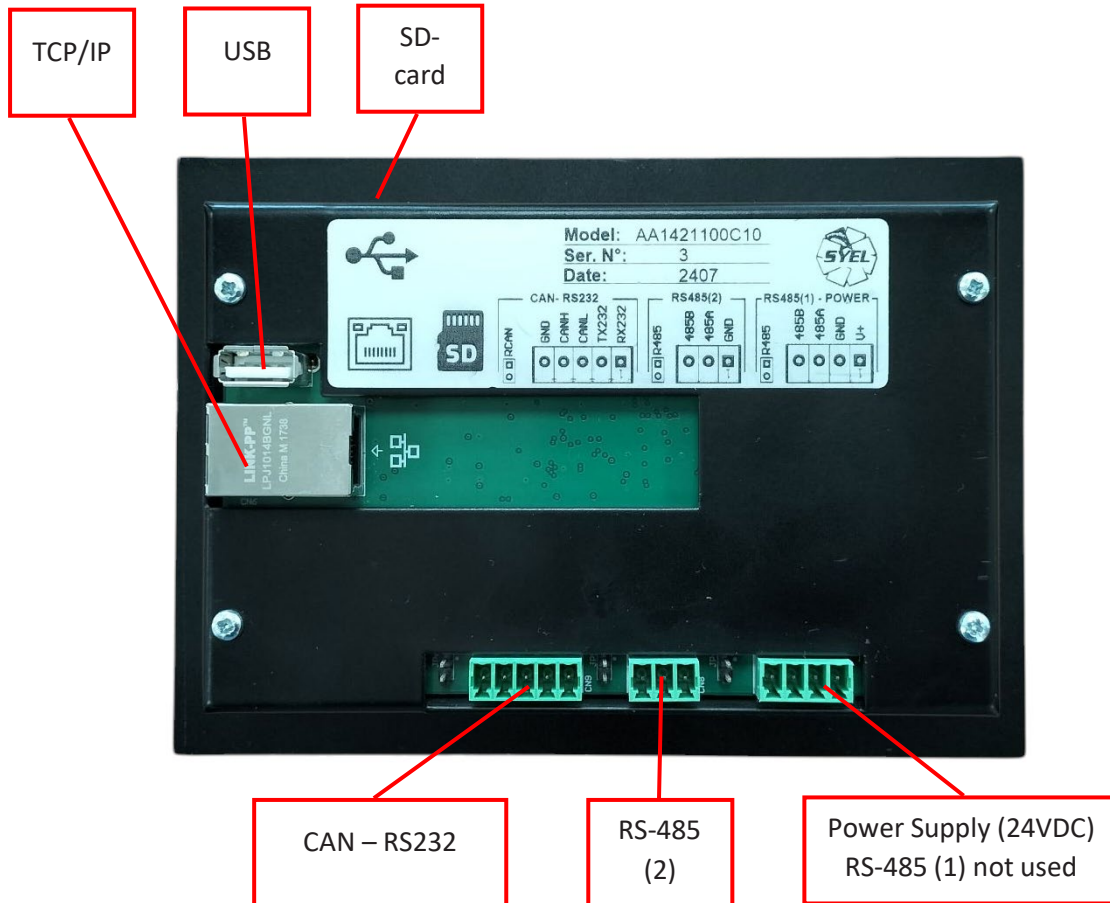

PRIO-print:

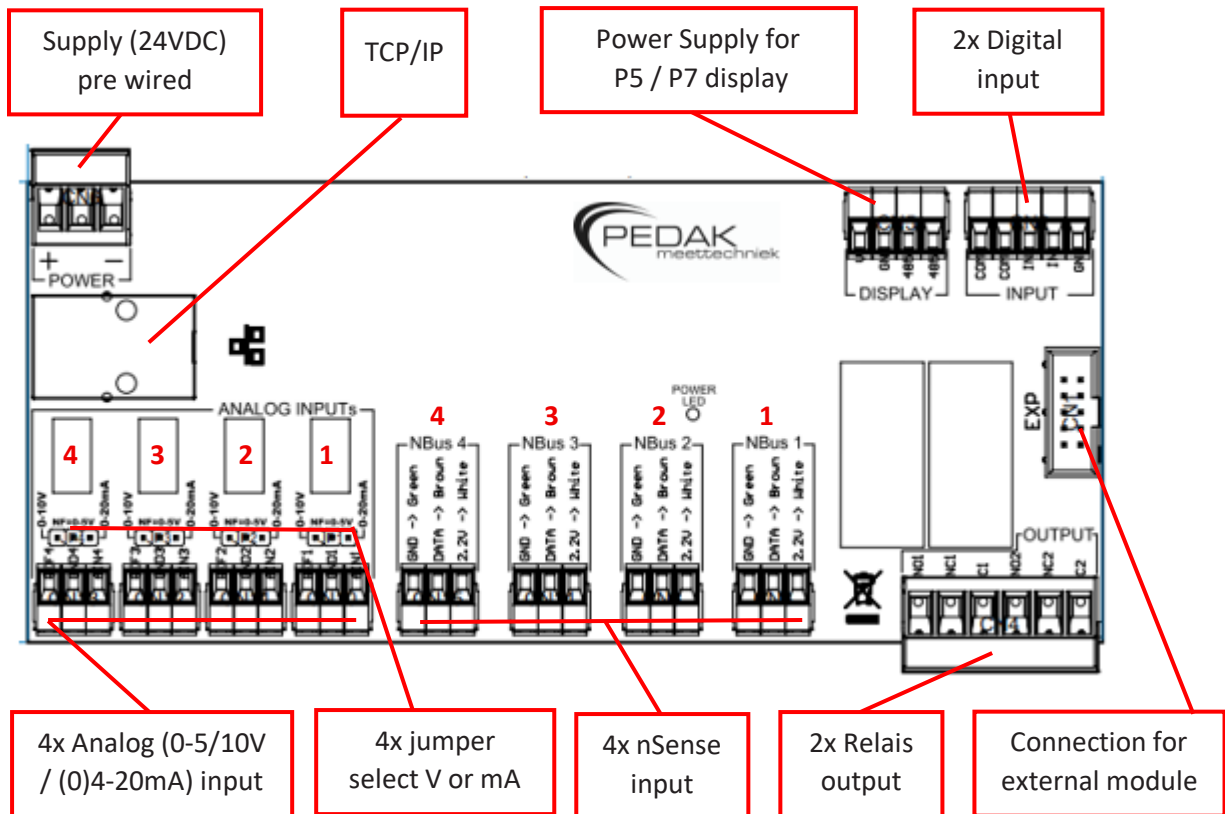

Connection Display with PRIO-box (via UTP cable / RJ45 cable)

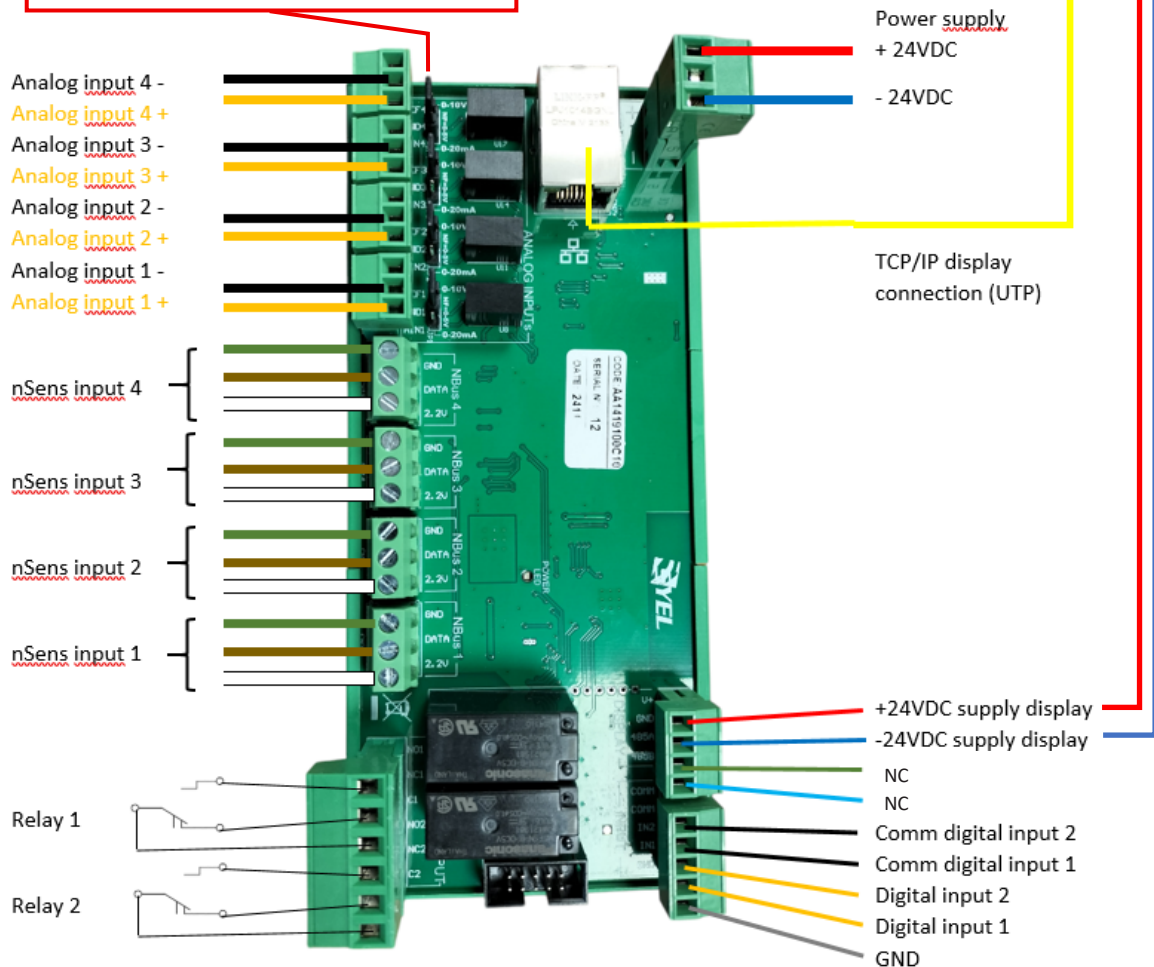
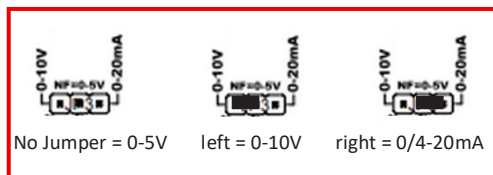
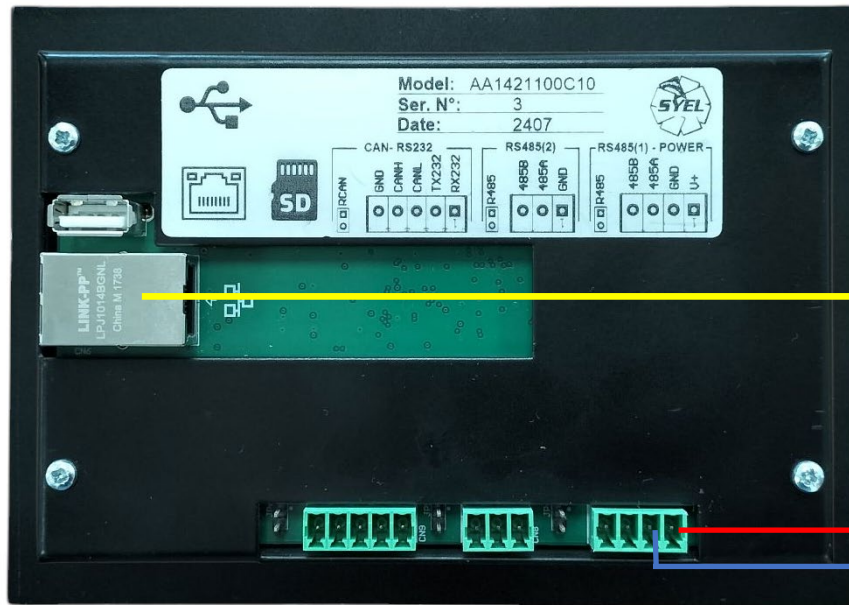

Connection Display Modbus TCP/IP (Modbus-Server or Modbus-Switch)

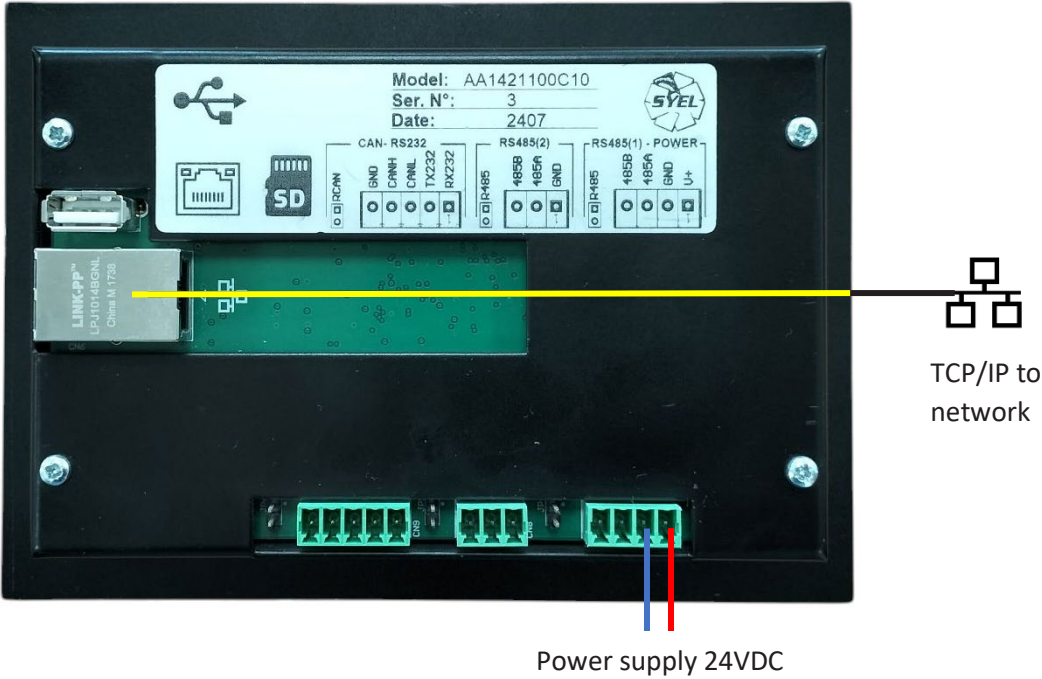

Connection Display with Modbus RS-485 (Modbus-Client)

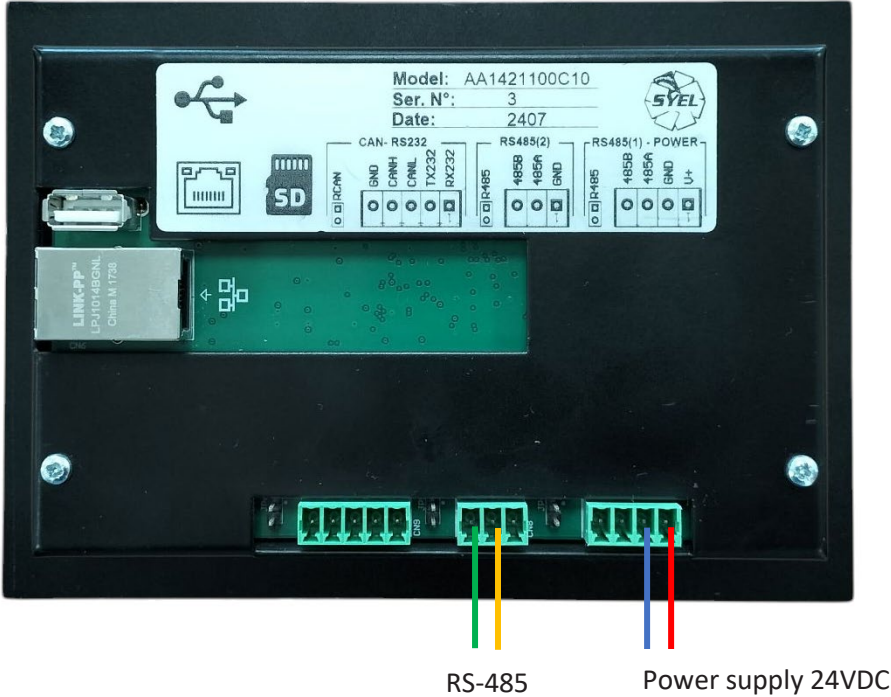

⚠ NOTE: The RS-485 connection can be used next to the PRIO-box on the display.
 But the RS-485 Baud rate must **not** be set higher than **9600** !

5.1 MAIN SETTINGS:

Click on the **PEDAK logo** to enter the settings

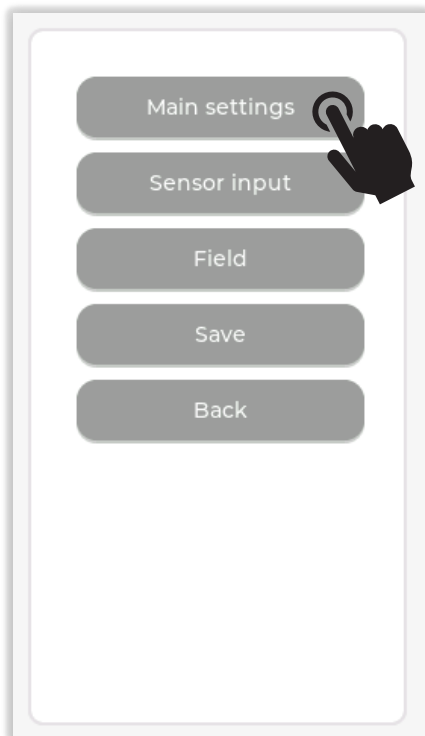

Main settings

Back

Language

Language: English

Brightness

Brightness day: 100

Brightness night: 10

Brightness delay (min): 0

Screen

Screen orientation: Horizontal

Number of active panels: 4

Pin code

Code: []

Pin code enabled: []

Wifi Network

Wifi name: Pedak

Password: Pedak1234

Enabled: []

Logfile information

Buzzer

Frequency: Normal

Network

Current IP: 192.168.0.200

IP settings

Time and Date

Time: 10:22:38

Date: 10-07-2025

System info

Factory reset

Restart

Switch version





In the “Main settings” overall configurations can be made, such as screen layout, screen orientation, language, PIN code, etc.

Language: Select the display language. Select Dutch or English (default)

Brightness: Set the Day and/or Night (energy save) brightness of the display.

Default Day = 100%,

Default Night = 10%

Automatic switch from Day to Night modus by setting a delay time (in minutes)

Setting no delay time the automatic switch modus is OFF

Screen: Select the display layout. Horizontal (landscape) or Vertical (portrait)

Select how many active Fields you prefer. 1 up to max. 8 visible fields.

See [Chapter 12](#) for “Screen Layout”

Pin code: To protect the display for unauthorized use a PIN code can be set.

For the PIN code to be active you need to enable the Pin code



If you forget the PIN code the display has to be returned to **PEDAK meettechniek** to be reset !

Wifi network: The display saves the measured values on the SD-card, by using the Wifi connection you can download the saved data on your smartphone for analyses *
[See [Chapter 8](#): “Download the LogFile via Wifi” for instructions].

Buzzer: Set the buzzer frequency to Normal or Low for different buzzer tones.

Network: If the display is connected via TCP/IP to your network the visible IP address can be used for Modbus communications.

Via IP SETTINGS several network settings can be made.

[See [chapter 9](#): “Modbus” for instructions and Modbus registers]

Time and Date: Set the correct Time and Date

Time is showed in the display at all times, date is used for graphics

System info: Here the serial number, firmware version and the company info is shown **

Factory Reset: Select to set the display back to default factory settings [see [chapter 10](#)].



All the user programmed settings are erased !

Restart: Select to Restart the display without disconnecting the power supply.



All Graphics are reset ! [Logfiles will remain]

Switch version: Select to switch to Modbus only (slave) modus (TCP/IP) *** [see [chapter 9](#)]



Every setting must be done via Modbus !

* (Logfile information)

Connect to the WiFi network: Pecak
Scan the QR code and click on the link to access the datalog files.
Possible warning: If a "unsecured website" warning appears, still proceed.



Touch the screen to go back

** (System information)



T +31 (0)475 49 74 24
E info@pedak.nl
W www.pedak.nl

Serial number: 12345
Firmware version: V1.0



Touch the screen to go back

*** (Switch Version)

IP settings

Time and Date

Time 13:41:52

Date

System info

Factory reset

Restart

Switch version

Back

Confirmation
Do you want to switch to the "Modbus only" edition of the software?
Yes No

5.2 SENSOR INPUT:

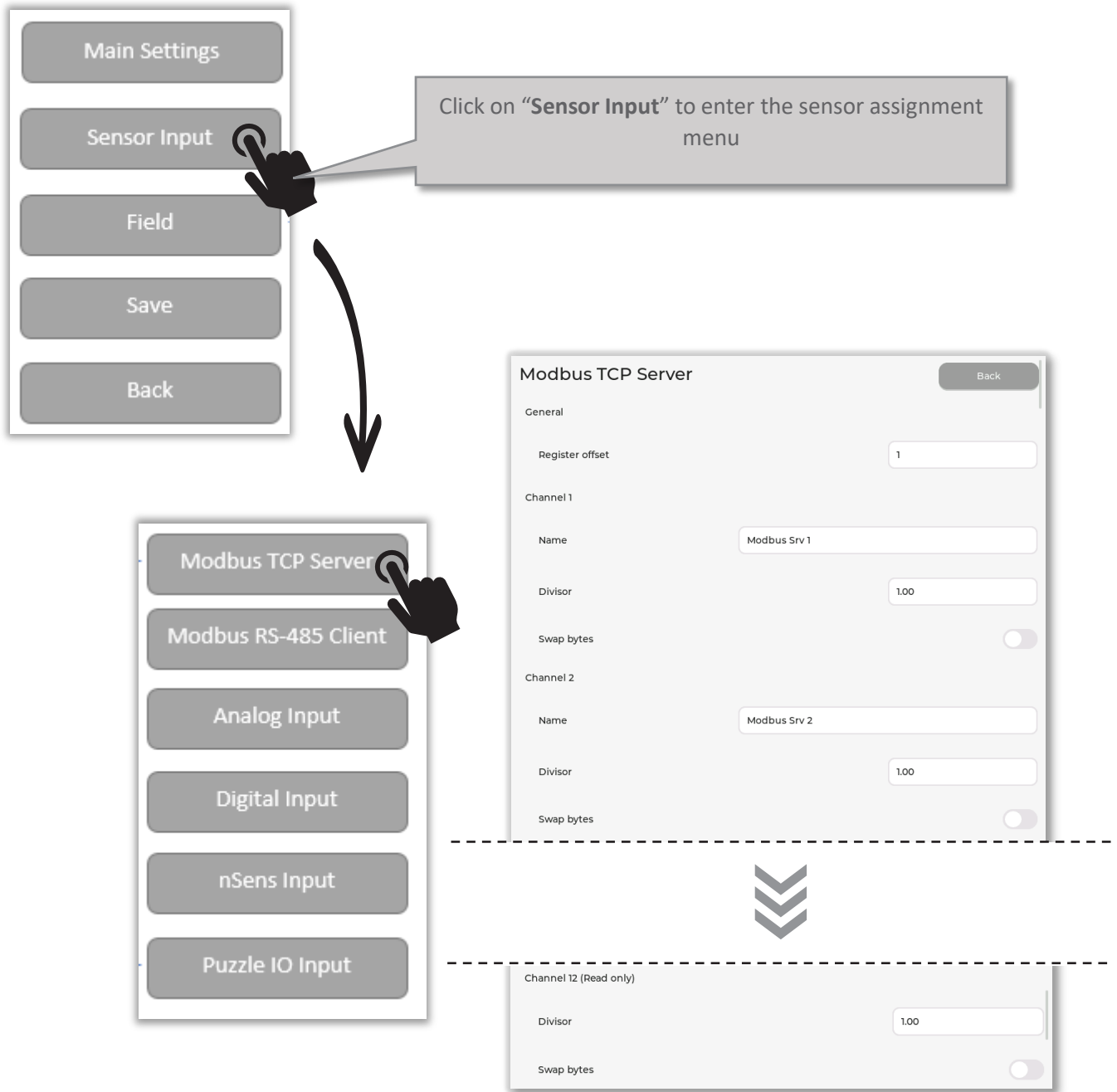

This input can be used to send the measured values to the display via TCP/IP connection.

NOTE: Measured values only, the rest of the settings must be done via the “Field” menu!

NOTE: You also need to set the IP-address via “Main Settings”

Register offset: Start address for the Modbus register

Channel 1 – Name: Enter your channel name (default: Modbus Srv 1)

Divisor: Sometimes it is needed to divide the input register to get the correct reading, enter the divisor value for correct readings.

Example: input register is 500 → reading should be 50 → divisor = 10

Swap bytes: Sometimes it is needed to swap bytes, this can be done by using the switch 

These settings must be done for each Channel separately.

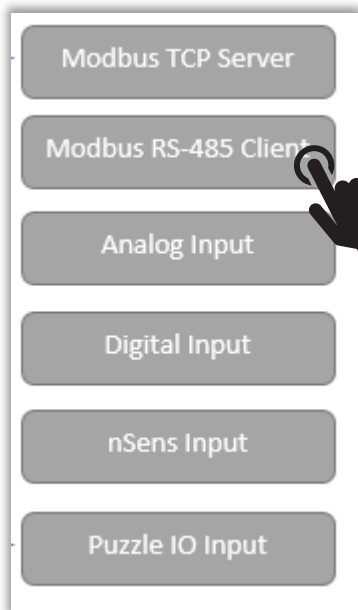

Modbus RS485 Client

Serial settings

Baud rate: 115200

Data bits: 8

Parity: None

Stop bits: 1

Channel 1

Name: Modbus Cl 1

Register number: 1

Divisor: 1.00

Swap bytes:

Unit address: 1

Register type: Holding



Channel 8

Name: Modbus Cl 8

Register number: 8

Divisor: 1.00

Swap bytes:

Unit address: 1

Register type: Holding



This input can be used to send the measured values to the display via RS-485 connection.

NOTE: Measured values only, all other settings must be done via the “Field” menu!

NOTE: Make sure all settings of the sensor and display channel match!

Serial Settings: Enter the serial settings matching the sensor settings

Channel 1 – Name: Enter your channel name (default: Modbus Cl 1)

Register number: Enter the register number you want to be displayed

Divisor: Sometimes it is needed to divide the input register to get the correct reading, enter the divisor value for correct readings.

Swap bytes: Sometimes it is needed to swap bytes, this can be done by using the switch

Unit address: Enter the Unit address of the sensor you want to be displayed

Register type: Choose the needed register type (Holding or Integer)

These settings must be done for each Channel separately.

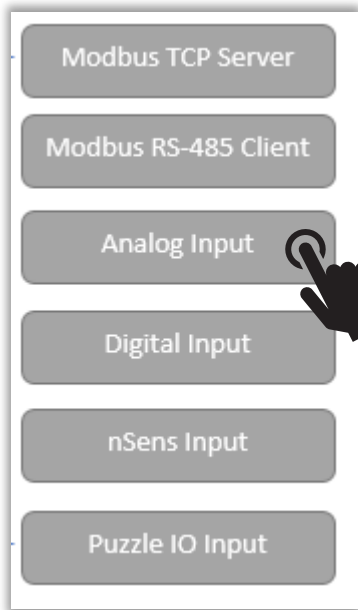

Analog input Back

Channel 1

Name

Input

Input Min.

Input Max.

Range Min.

Range Max.

Smoothing



Channel 4

Name

Input

Input Min.

Input Max.

Range Min.

Range Max.

Smoothing



This input can be used to display Analog (mA/VDC) signals or Analog sensors via the PRIO-box.

NOTE: Measured values only, all other settings must be done via the "Field" menu!

NOTE: Make sure all Sensor settings and Display channel settings match!

Channel 1 – Name: Enter your channel name (default: Analog 1)

Input: Select the Analog signal (0/4-20mA, 0-5/10VDC)¹ *[it must match the sensor]*

Input Min: low calculation value (fixed value)

Input Max: High calculation value (fixed value)

Range Min: Enter the low measuring value that needs to be displayed *[it must match the sensor]*

Range Max: Enter the High measuring value that needs to be displayed *[it must match the sensor]*

Smoothing: Enter the Smoothing² value *[value between 0-100%]* (default: 98,06)

These settings must be done for each Channel separately.

¹ Also put the Jumper(s) in the correct position!

² This function converts the selected "smoothing" setting into a value that the EMA (Exponential Moving Average) filter uses to smooth measurements. The higher the smoothing, the smoother the signal appears, but the slower it reacts to rapid changes.

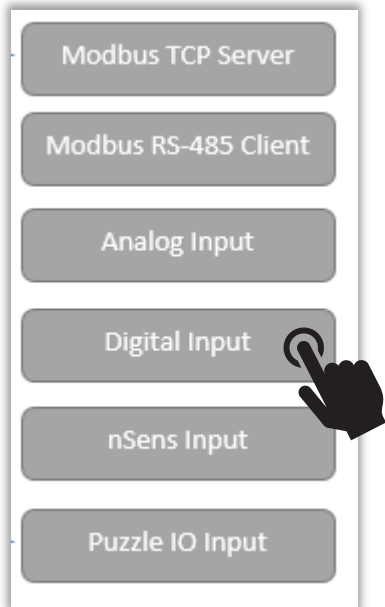

Digital inputs Back

Input 1

Name

Channel

Input type

Input 2

Name

Channel

Input type

Input 16

Name

Channel

Input type



This input can be used as a counter of to show text on the Display via the PRIO-box.
NOTE: Digital input only, the rest of the settings must be done via the “Field” menu!
NOTE: PRIO-box has 2 digital inputs, this can be extended up to 16 digital inputs!

Input 1 - Name: Enter your channel name (default: Digital 1)

Channel: Select the digital channel to be used

Input type: Select if you want the digital input to behave as a Counter or State function.

Counter function¹: adds the value with 1 at each pulse (24VDC)

State function²: shows the added text as long as the pulse is high (24VDC)

These settings must be done for each Channel separately.

¹ Counter can be **RESET** by touching the counter screen for >2 sec.

² State settings via the FIELD menu at “Channel can be disabled”, enable the function , choose the digital input you want to use and enter the “Disable Text” you want to be displayed when the Digital input is activated

Channel can be disabled

Disable enable

Disable channel

Disable tekst

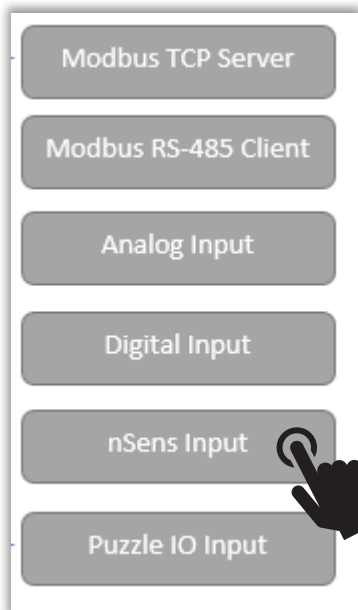

nSens sensor input

Back

Probe 1 Value 1

Name

Probe 1 Value 2

Name

Probe 2 Value 1

Name

Probe 2 Value 2

Name

Probe 3 Value 1

Name

Probe 3 Value 2

Name

Probe 4 Value 1

Name

Probe 4 Value 2

Name



This input can be used to display Novasina nSens/nLink+ sensors via the PRIO-box.

NOTE: Measured values only, the rest of the settings must be done in via the “Field” menu!

NOTE: Make sure all Sensor settings and Display channel settings match!

NOTE: max. 4x nSens can be connected to the PRIO-box

NOTE: 1 nSens can have more the 1 measuring value output !

for example: 1 sensor can have Humidity and Temperature output so if you need them to be displayed both you must enter “Probe 1 value 1” in “Field 1” and “Probe 1 Value 2” in “Field 2” (or whichever field you prefer)

Probe 1 Value 1 - Name: Enter your Sensor name (default: nSens 1 Value 1)

These settings must be done for each Channel separately.

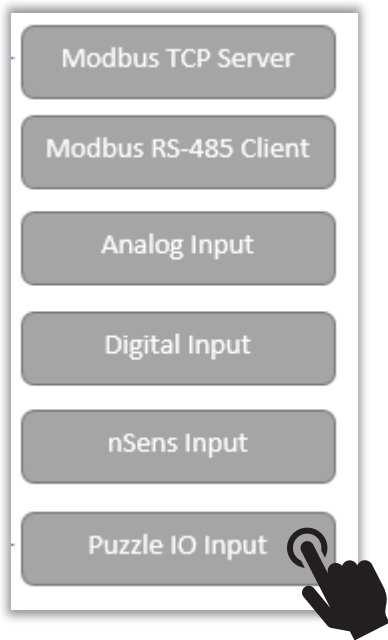

Analog input Back

Channel 1

Name

Input Min.

Input Max.

Range Min.

Range Max.



Channel 8

Name

Input Min.

Input Max.

Range Min.

Range Max.



This input can be used to display extra Analog (mA/VDC) or digital signals via the PRIO-box with expanded Puzzle modules [see chapter 11].

NOTE: Measured values only, the rest of the settings must be done via the “Field” menu!

NOTE: Make sure all Sensor settings and Display channel settings match!

Channel 1 – Name: Enter your channel name (default: P Analog 1)

Input Min: low calculation value (0.00 for 0V or 0mA input / 826 for 4mA input, or custom)

Input Max: High calculation value (4096 for 5V/10V/20mA, or custom)

Range Min: Enter the low measuring value that needs to be displayed, it must match the sensor

Range Max: Enter the High measuring value that needs to be displayed, it must match the sensor

These settings must be done for each Channel separately.

Example: Analog Sensor → measuring range 0...50°C with 4...20mA output

Input Min. → 819 (matches 4 mA)

Input Max. → 4096 (matches 20 mA)

Range Min. → 0 (matches 0°C)

Range Max. → 50 (matches 50°C)



Puzzle Modules can only be used in combination with the PRIObox and have **NO** galvanic insulation!

5.3 FIELD:

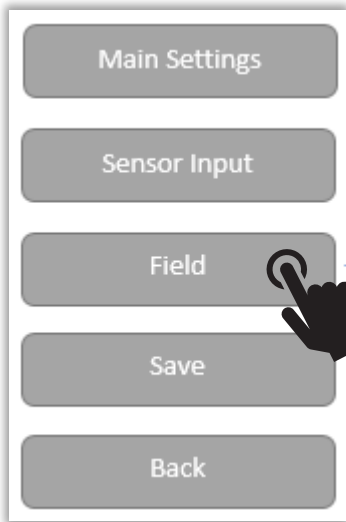

Field 1

Back

Sensor input: Analog 1

Text left: Temperature

Text right: Room 1

Unit: °C

Decimals: 1

Background green:

Logging to file enabled:

Channel can be disabled:

Disable enable:

Disable channel:

Disable tekst:

Toggle panel:

Is toggle panel:

Relais connected to toggle: 0

Graph:

Manual scaling enabled:

Graph minimum: 0.0

Graph maximum: 100.0

Alarm:

Enabled:

Alarm delay (sec): 0

Low Settings

High Settings





In the “Field” menu settings can be made for each individual Field according the measured values, Alarms, Text, Background colour, etc.

Sensor input: Select the input you want to show in the specified field [*default: Analog 1*]

Text left: Enter the Text to be shown in the left upper side of the specified field

 Text may overlap “Text Right” if too long !

Text right: Enter the Text to be shown in the right upper side of the specified field

 Text may overlap “Text Left” if too long !

Unit: Enter Unit to be shown behind the measured value [*it must match the sensor*]

Decimals: Enter the number of decimals you want to show

Background green: Select if you want the background to be white or green at no Alarm status

Logging to file enabled – disable enable: Select if the measured data must be saved

Disable channel: Select the channel you want to be disabled¹ [*it must be an active channel*]

Disable text: Enter the text you want to show if the specified channel is disabled

Toggle panel: Select if the field should toggle² and specify the relay to be used

Relay connected to toggle: Select the relay you want to be active during toggle [*default 1 or 2*]

Graph – Manual scaling enabled: Select between auto scaling or manual scaling

Graph minimum: Enter the value of graphical minimum [*at manual scaling only*]

Graph maximum: Enter the value of graphical maximum [*at manual scaling only*]

Alarm - Enabled: Select if the alarm should be enabled or disabled

Alarm delay (sec.): Enter the second(s) the alarm should be delayed

These settings must be done for each Field separately.

¹ State settings via the FIELD menu at “Channel can be disabled”, enable the function , choose the digital input you want to use and enter the “Disable Text” you want to be displayed when the Digital input is activated

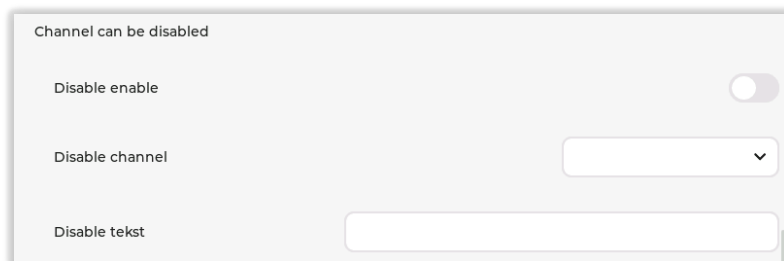

Channel can be disabled

Disable enable

Disable channel

Disable tekst

² With the Toggle function a specified field can be used to switch a relay ON/OFF [*all other functions of the specified field are disabled if the Toggle function is active*]

Field 1

Back



Low Settings

High Settings



Low Settings Field 1

Back

Low Settings

Warning

Value

0.0

Hysteresis

0.0

Enabled



Buzzer enabled



Digital output channel

0

Alarm

Value

0.0

Hysteresis

0.0

Enabled



Buzzer enabled



Digital output channel

0



Field 1

Back



Low Settings

High Settings



High Settings Field 1

Back

High Settings

Warning

Value

0.0

Hysteresis

0.0

Enabled



Buzzer enabled



Digital output channel

0

Alarm

Value

0.0

Hysteresis

0.0

Enabled



Buzzer enabled



Digital output channel

0



Low or High Alarm settings (Field 1 ...8)



Warning: the background colour will change from white/green to yellow

Value: enter the value at which the warning should be enabled

Hysteresis: enter the value on which warning should be enabled/disabled

Enabled: select if the warning alarm should be ON or OFF

Buzzer enabled: select if the buzzer should ON or OFF at a warning alarm

Digital output channel: select the digital output which should be enabled at a warning alarm (0 = NO digital output is selected)

Alarm: The background colour will change from white/green/yellow to red

Value: enter the value at which the alarm should be enabled

Hysteresis: enter the value on which alarm should be enabled/disabled

Enabled: select if the alarm should be ON or OFF

Buzzer enabled: select if the buzzer should ON or OFF at an alarm

Digital output channel: select the digital output which should be enabled at an alarm (0 = NO digital output is selected)



These Lo/High warning and alarms need be set for each field separately

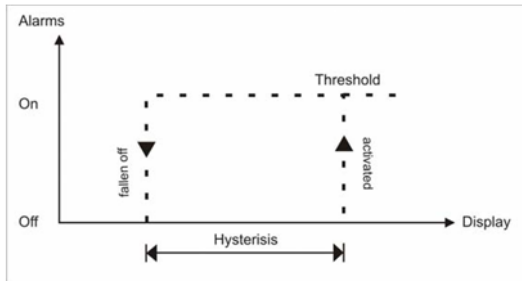

Operating current

By operating current the alarm is OFF below the threshold and ON at reaching the threshold.

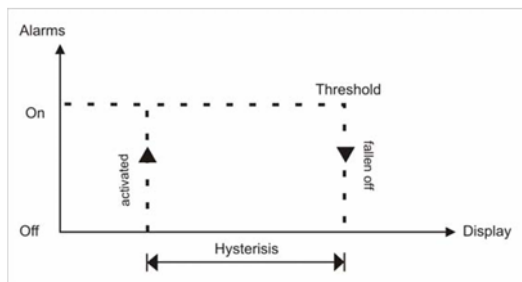

Quiescent current

By quiescent current the alarm is ON below the threshold and switched OFF on reaching the threshold.

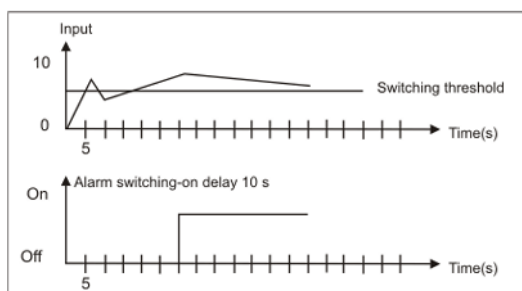

Switching-on delay

The switching-ON delay is activated via an alarm and e.g. switched 10 seconds after reaching the switching threshold, a short-term exceedance of the switching value does not cause an alarm, respectively does not cause a switching operation of the relay. The switching-OFF delay operates in the same way, keeps the alarm / the relay switched longer for the parametrised time.

5.4 SAVE:

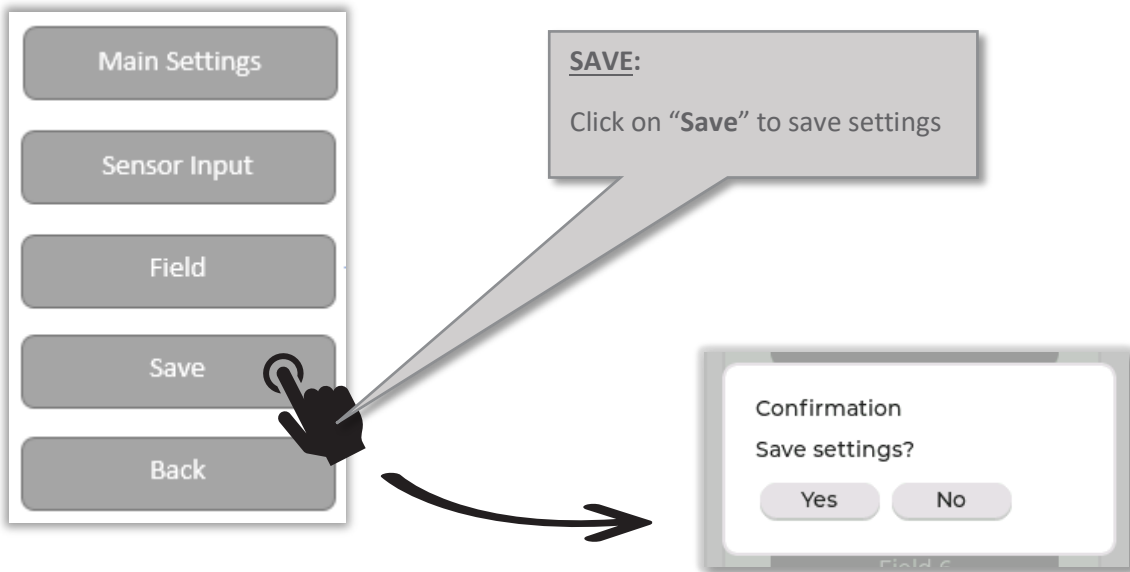

5.5 BACK:

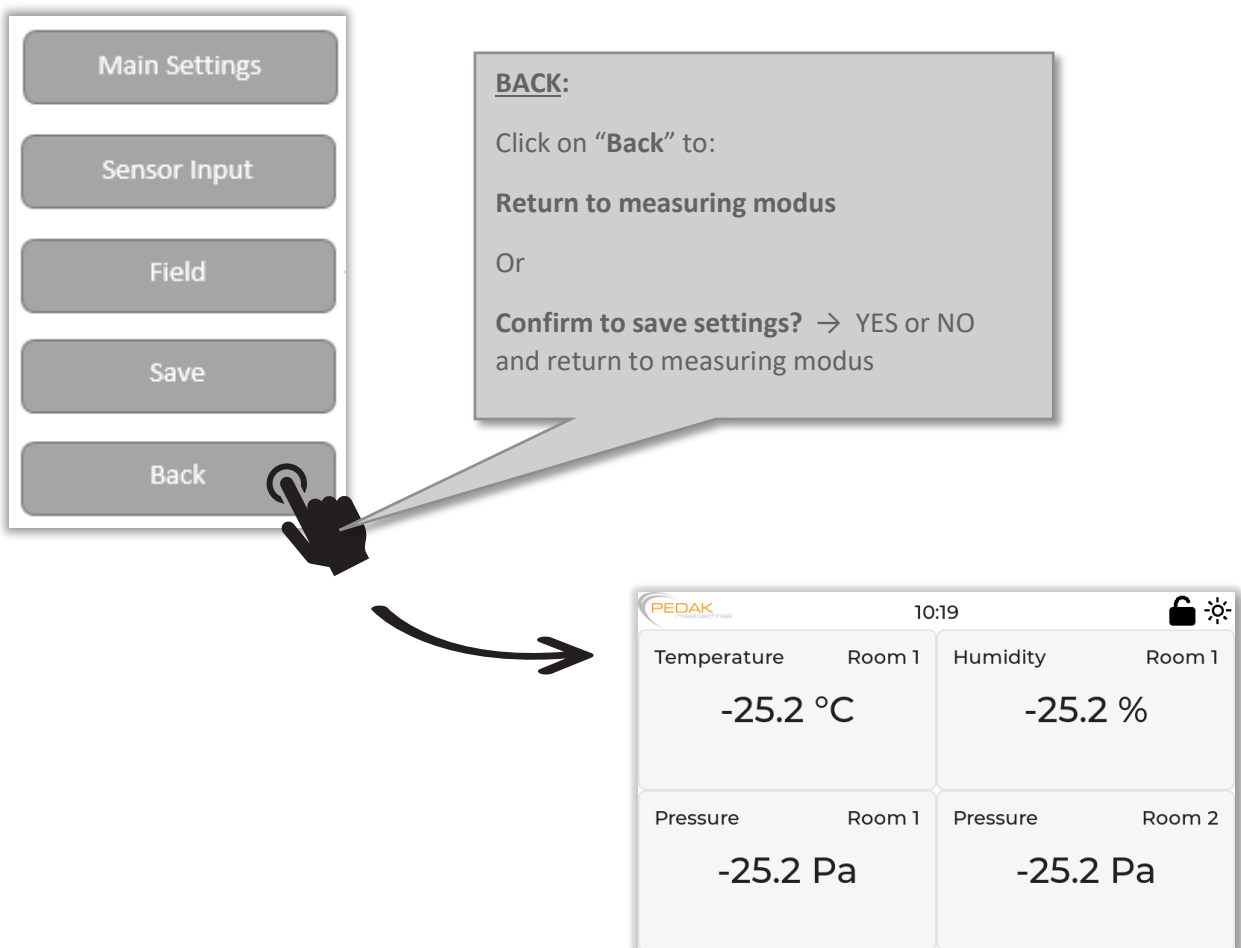

6 OUT OF USE FUNCTION:

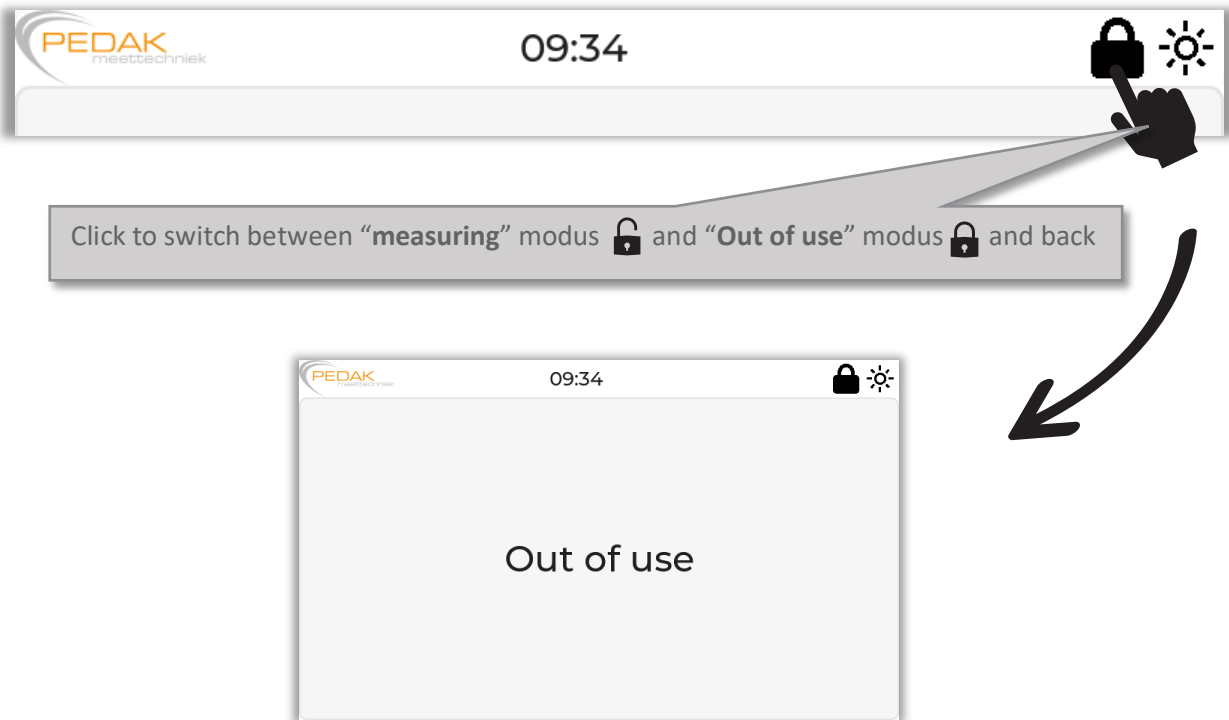

7 DAY – NIGHT FUNCTION:

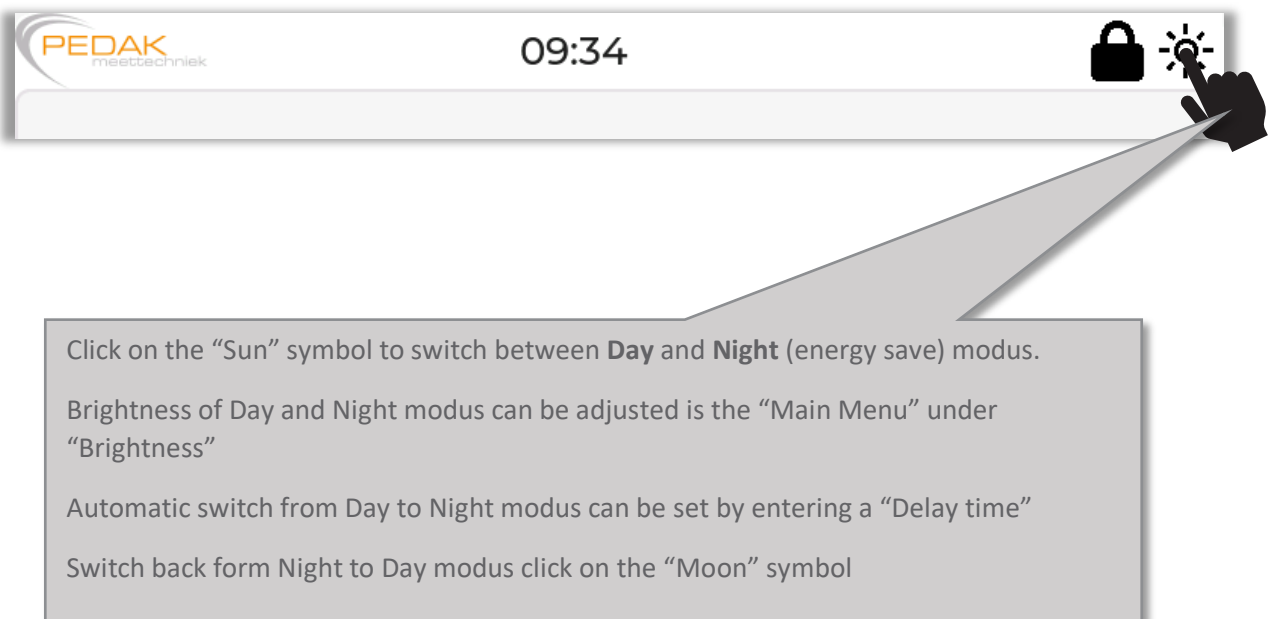

8 DOWNLOAD THE LOGFILE VIA Wi-Fi

The saved data can be download from the display via the Wi-fi option to you smartphone and opened as a .CSV file. The saved data also can extracted from the SD-card, the SD-card has to be removed from the display and put into a computer. Files can be found in the "Logging" folder.

[Wi-Fi only active with the PRIObox]

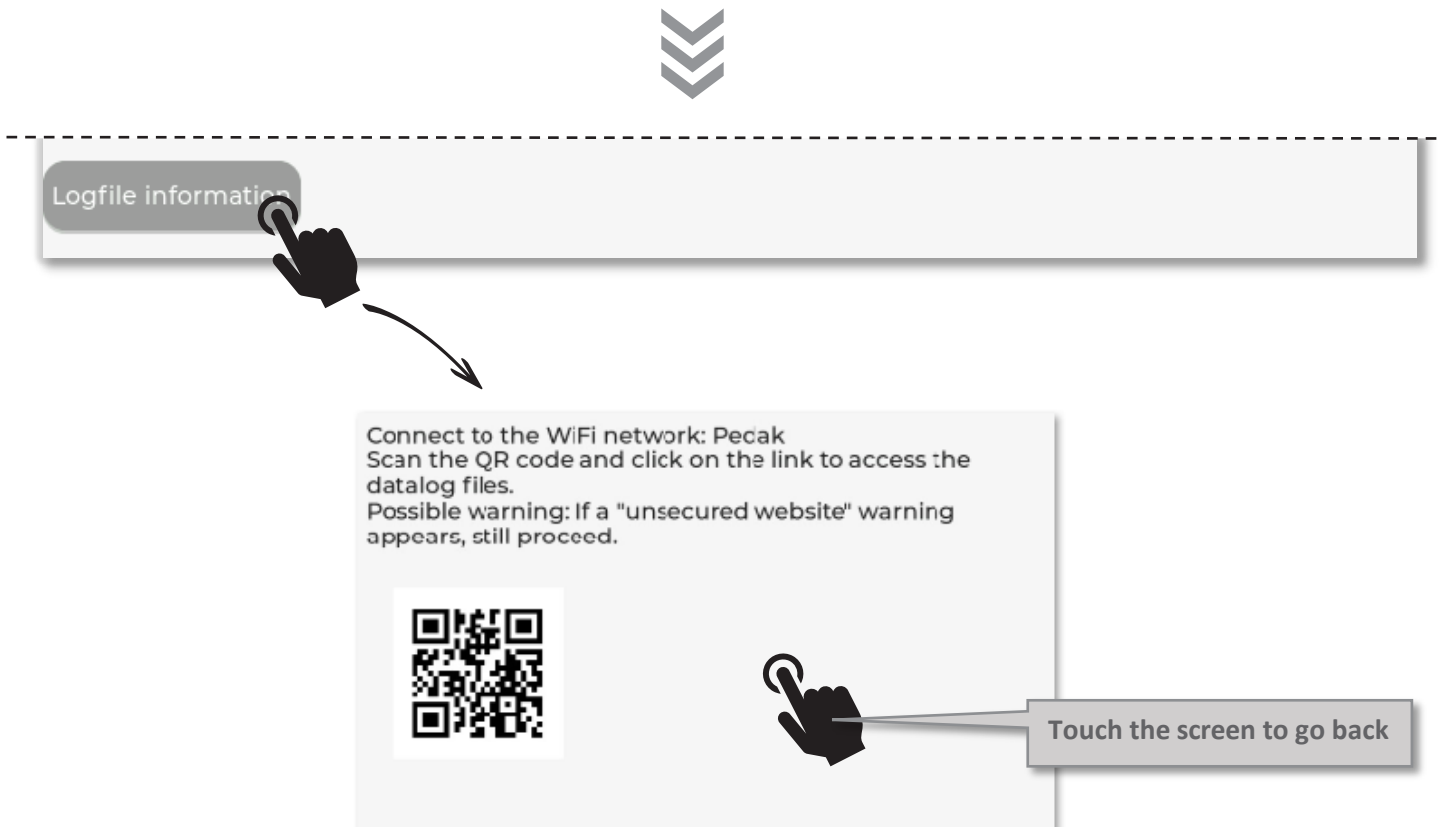
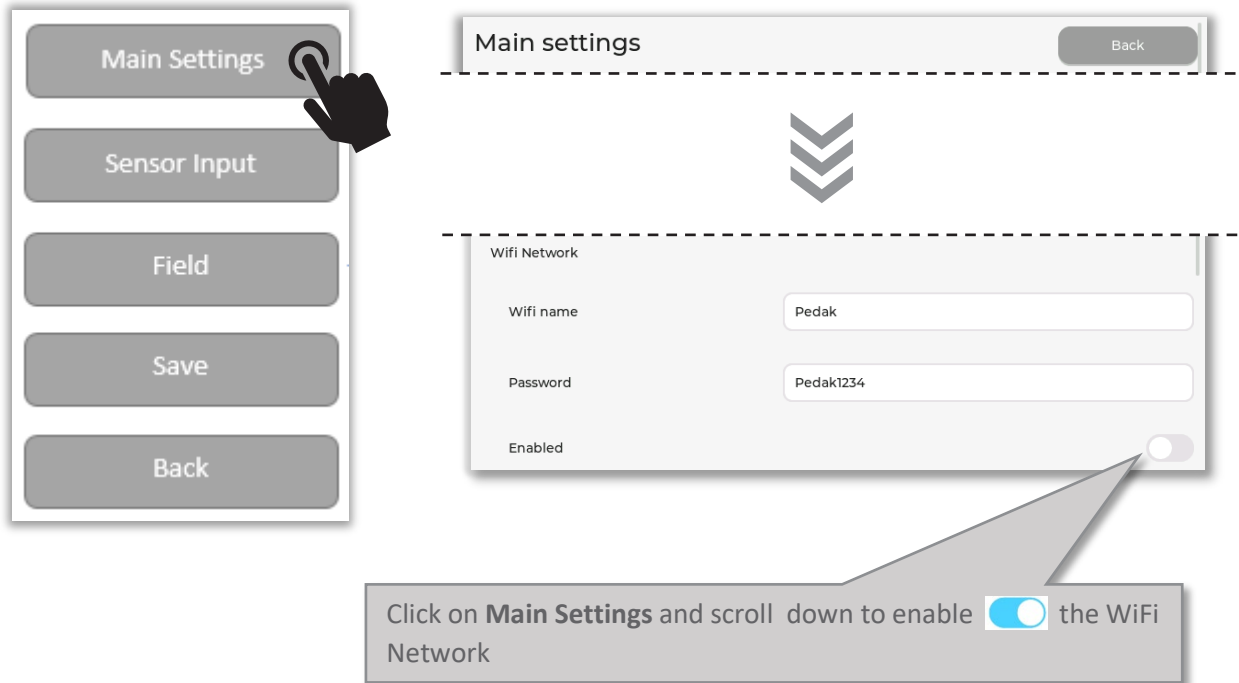

If your smartphone Wi-fi network is set to **PEDAK (password Pedak1234)** and the QR-code is scanned you enter the **neverssl.com** website or enter the **neverssl.com** website manually via the browser.

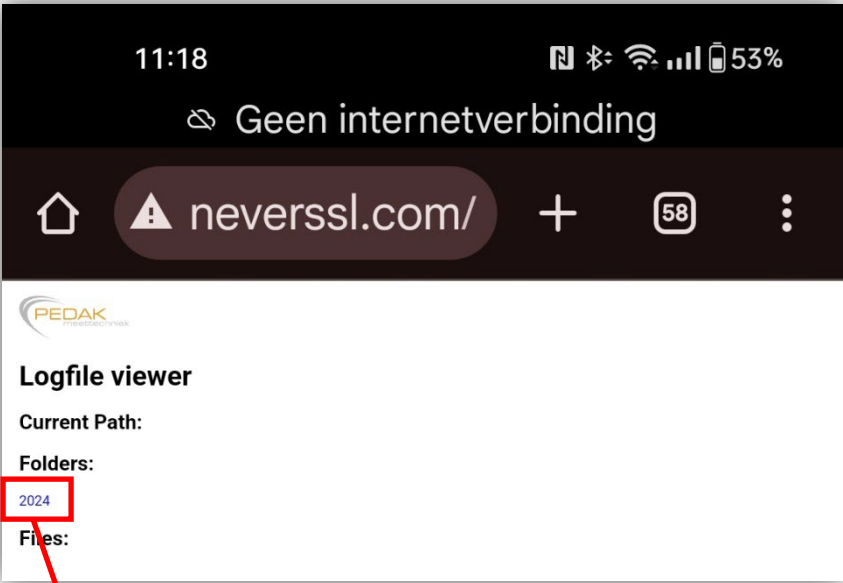

Select the desired folder

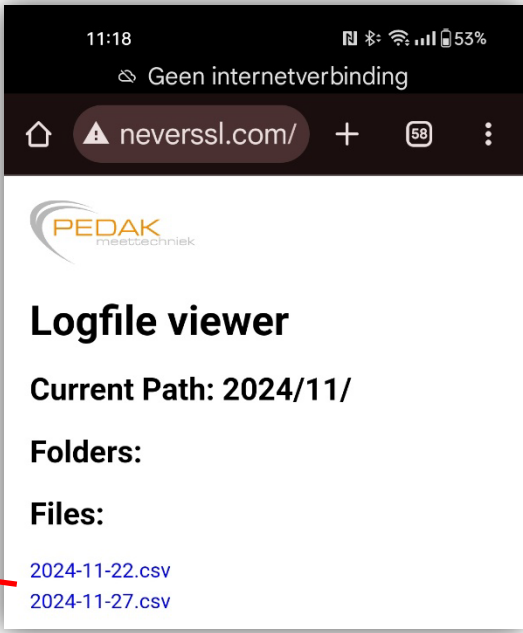
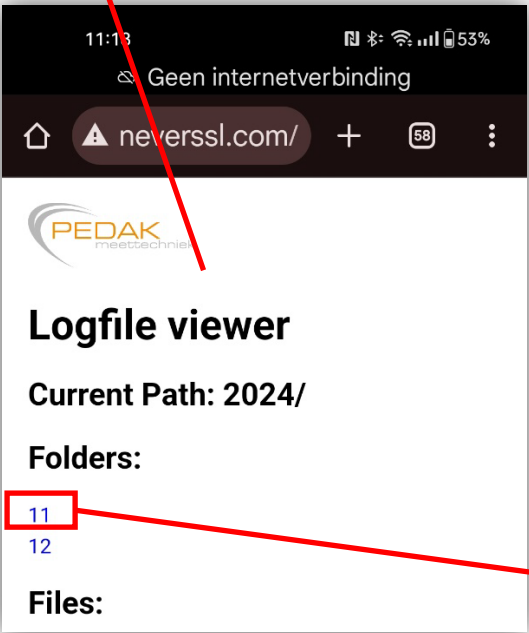

Click on the .csv file you want to download to view the LogFile.

9 MODBUS:

Modbus TCP/IP (Switch – Slave)

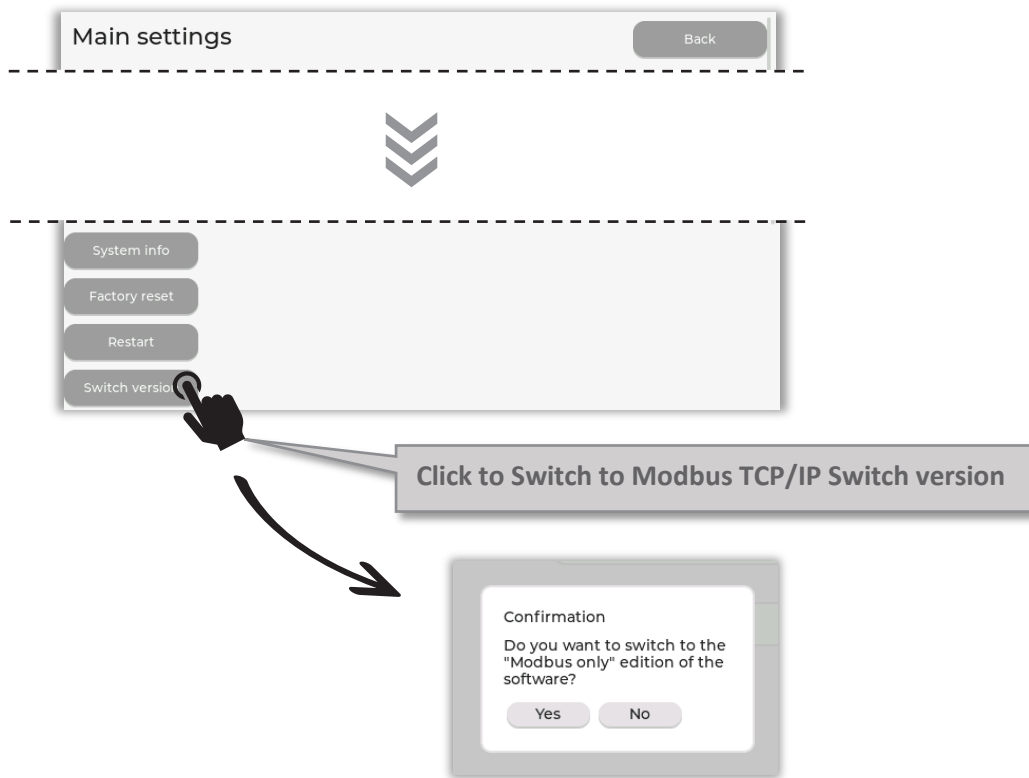

The display can be used as Modbus only (Slave) device. All settings must be done over the Modbus TCP/IP connection *[settings made in all other menu's will be ignored]*

The IP address to be used is shown in the display if confirmed to use "Switch Version", this is the same IP address as shown under "Current IP" in the "Main settings" menu.

This IP address can be changed via "IP settings" in the "Main settings" menu in standard modus.

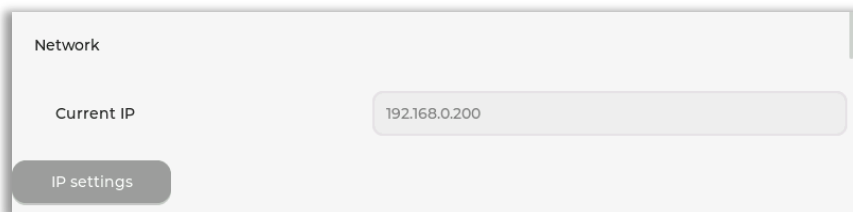

If you change the IP-address you have **Save** and **Restart** the display, with the buttons at the bottom of the IP-settings menu, to be active !

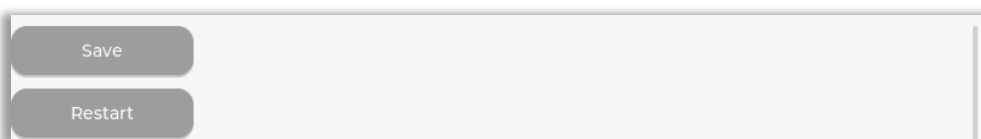

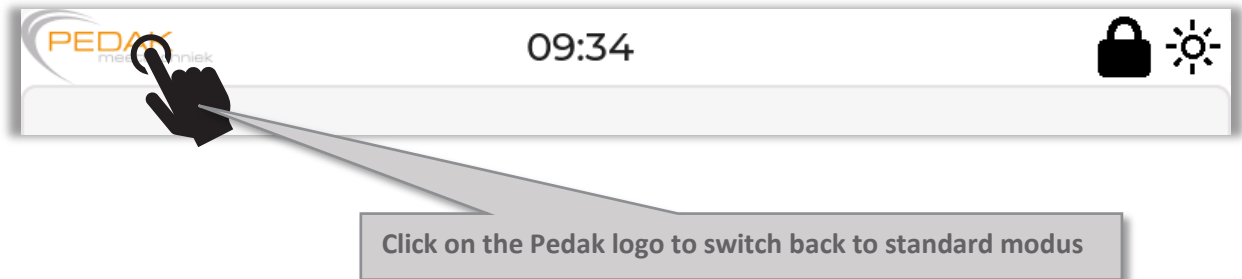

 The data is saved on the SD-card but cannot be extracted via WiFi in the Modbus-Switch modus

 If you want to switch back to the Standard Modus click on the Pedak logo and confirm you want to switch back.



Modbus TCP/IP (Server – Master)

 The display can be used as Modbus (Server - Master) device.
Only the measured values can be send to the display over Modbus TCP/IP connection, all other settings (like Alarms, Name, Delay, Hysteresis, etc.) must be done in the “Field” settings menu.
The rest of the Modbus settings can be made via “Sensor input” and “Modbus TCP Server”
[see chapter 5.2]

 The data is saved on the SD-card but cannot be extracted via WiFi in the Modbus-TCP/IP modus

 The maximum of displays in a Modbus line is in theory “unlimited” on a class A network and max. 100m cable length and using the correct peripheral equipment (router, etc.)

Modbus RS-485 (Client – Master)

 The display can be used as Modbus (Client - Master) device.
Only the measured values can be send to the display over Modbus RS-485 connection, all other settings (like Alarms, Name, Delay, Hysteresis, etc.) must be done in the “Field” settings menu.
The rest of the Modbus settings can be made via “Sensor input” and “Modbus RS485 Client ”
[see chapter 5.2]

 The data is saved on the SD-card but cannot be extracted via WiFi in the Modbus-RS485 modus

 Max. 32 displays in one Modbus line, depending on the quality (electrical load) of the network.

Modbus Registers

Register start	Register end	Datatype	Value	Notes
1	2	Float (32 bits, Little Endian)	Modbus 1, analog value channel 1	
3	4	Float (32 bits, Little Endian)	Modbus 2, analog value channel 2	
5	6	Float (32 bits, Little Endian)	Modbus 3, analog value channel 3	
7	8	Float (32 bits, Little Endian)	Modbus 4, analog value channel 4	
9	10	Float (32 bits, Little Endian)	Modbus 5, analog value channel 5	
11	12	Float (32 bits, Little Endian)	Modbus 6, analog value channel 6	
13	14	Float (32 bits, Little Endian)	Modbus 7, analog value channel 7	
15	16	Float (32 bits, Little Endian)	Modbus 8, analog value channel 8	
31		Bitpattern 16 bits	Modbus 1, alarm status	Bit 0: Warning status; Bit 1: Alarm status; Bit 2: Buzzer on; Bit 3: Buzzer muted; Note: Buzzer will only sound if warning of alarm is active
32		Bitpattern 16 bits	Modbus 2, alarm status	Bit 0: Warning status; Bit 1: Alarm status; Bit 2: Buzzer on; Bit 3: Buzzer muted; Note: Buzzer will only sound if warning of alarm is active
33		Bitpattern 16 bits	Modbus 3, alarm status	Bit 0: Warning status; Bit 1: Alarm status; Bit 2: Buzzer on; Bit 3: Buzzer muted; Note: Buzzer will only sound if warning of alarm is active
34		Bitpattern 16 bits	Modbus 4, alarm status	Bit 0: Warning status; Bit 1: Alarm status; Bit 2: Buzzer on; Bit 3: Buzzer muted; Note: Buzzer will only sound if warning of alarm is active
35		Bitpattern 16 bits	Modbus 5, alarm status	Bit 0: Warning status; Bit 1: Alarm status; Bit 2: Buzzer on; Bit 3: Buzzer muted; Note: Buzzer will only sound if warning of alarm is active
36		Bitpattern 16 bits	Modbus 6, alarm status	Bit 0: Warning status; Bit 1: Alarm status; Bit 2: Buzzer on; Bit 3: Buzzer muted; Note: Buzzer will only sound if warning of alarm is active
37		Bitpattern 16 bits	Modbus 7, alarm status	Bit 0: Warning status; Bit 1: Alarm status; Bit 2: Buzzer on; Bit 3: Buzzer muted; Note: Buzzer will only sound if warning of alarm is active
38		Bitpattern 16 bits	Modbus 8, alarm status	Bit 0: Warning status; Bit 1: Alarm status; Bit 2: Buzzer on; Bit 3: Buzzer muted; Note: Buzzer will only sound if warning of alarm is active
41		Integer (16 bits, Little Endian)	Channel 1, number of decimals	In case the value is set higher than 10, a value of 10 is used instead
42		Integer (16 bits, Little Endian)	Channel 2, number of decimals	In case the value is set higher than 10, a value of 10 is used instead
43		Integer (16 bits, Little Endian)	Channel 3, number of decimals	In case the value is set higher than 10, a value of 10 is used instead
44		Integer (16 bits, Little Endian)	Channel 4, number of decimals	In case the value is set higher than 10, a value of 10 is used instead
45		Integer (16 bits, Little Endian)	Channel 5, number of decimals	In case the value is set higher than 10, a value of 10 is used instead
46		Integer (16 bits, Little Endian)	Channel 6, number of decimals	In case the value is set higher than 10, a value of 10 is used instead
47		Integer (16 bits, Little Endian)	Channel 7, number of decimals	In case the value is set higher than 10, a value of 10 is used instead
48		Integer (16 bits, Little Endian)	Channel 8, number of decimals	In case the value is set higher than 10, a value of 10 is used instead
101	115	Char (2x 8 bits ascii, Little Endian)	Channel 1, panel name	Last byte will be set to NULL
116	130	Char (2x 8 bits ascii, Little Endian)	Channel 1, Unit	Last byte will be set to NULL
131	145	Char (2x 8 bits ascii, Little Endian)	Channel 1, room name	Last byte will be set to NULL
146	160	Char (2x 8 bits ascii, Little Endian)	Channel 2, panel name	Last byte will be set to NULL
161	175	Char (2x 8 bits ascii, Little Endian)	Channel 2, Unit	Last byte will be set to NULL
176	190	Char (2x 8 bits ascii, Little Endian)	Channel 2, room name	Last byte will be set to NULL
191	205	Char (2x 8 bits ascii, Little Endian)	Channel 3, panel name	Last byte will be set to NULL
206	220	Char (2x 8 bits ascii, Little Endian)	Channel 3, Unit	Last byte will be set to NULL
221	235	Char (2x 8 bits ascii, Little Endian)	Channel 3, room name	Last byte will be set to NULL
236	250	Char (2x 8 bits ascii, Little Endian)	Channel 4, panel name	Last byte will be set to NULL
251	265	Char (2x 8 bits ascii, Little Endian)	Channel 4, Unit	Last byte will be set to NULL

266	280	Char (2x 8 bits ascii, Little Endian)	Channel 4, room name	Last byte will be set to NULL
281	295	Char (2x 8 bits ascii, Little Endian)	Channel 5, panel name	Last byte will be set to NULL
296	310	Char (2x 8 bits ascii, Little Endian)	Channel 5, Unit	Last byte will be set to NULL
311	325	Char (2x 8 bits ascii, Little Endian)	Channel 5, room name	Last byte will be set to NULL
326	340	Char (2x 8 bits ascii, Little Endian)	Channel 6, panel name	Last byte will be set to NULL
341	355	Char (2x 8 bits ascii, Little Endian)	Channel 6, Unit	Last byte will be set to NULL
356	370	Char (2x 8 bits ascii, Little Endian)	Channel 6, room name	Last byte will be set to NULL
371	385	Char (2x 8 bits ascii, Little Endian)	Channel 7, panel name	Last byte will be set to NULL
386	400	Char (2x 8 bits ascii, Little Endian)	Channel 7, Unit	Last byte will be set to NULL
401	415	Char (2x 8 bits ascii, Little Endian)	Channel 7, room name	Last byte will be set to NULL
416	430	Char (2x 8 bits ascii, Little Endian)	Channel 8, panel name	Last byte will be set to NULL
431	445	Char (2x 8 bits ascii, Little Endian)	Channel 8, Unit	Last byte will be set to NULL
446	460	Char (2x 8 bits ascii, Little Endian)	Channel 8, room name	Last byte will be set to NULL
501		Integer (16 bits, Little Endian)	Active channel count	Valid values are 1..8
502		Integer (16 bits, Little Endian)	Screen orientation	0 = Horizontal, 1 = Vertical
503		Integer (16 bits, Little Endian)	Screen brightness day	Valid values are 0..100
504		Integer (16 bits, Little Endian)	Screen brightness night	Valid values are 0..100
551		Bitpattern 16 bits	Channel 1, Settings	Bit 0: Green enabled; Bit 1: Manual scaling enabled
552		Bitpattern 16 bits	Channel 2, Settings	Bit 0: Green enabled; Bit 1: Manual scaling enabled
553		Bitpattern 16 bits	Channel 3, Settings	Bit 0: Green enabled; Bit 1: Manual scaling enabled
554		Bitpattern 16 bits	Channel 4, Settings	Bit 0: Green enabled; Bit 1: Manual scaling enabled
555		Bitpattern 16 bits	Channel 5, Settings	Bit 0: Green enabled; Bit 1: Manual scaling enabled
556		Bitpattern 16 bits	Channel 6, Settings	Bit 0: Green enabled; Bit 1: Manual scaling enabled
557		Bitpattern 16 bits	Channel 7, Settings	Bit 0: Green enabled; Bit 1: Manual scaling enabled
558		Bitpattern 16 bits	Channel 8, Settings	Bit 0: Green enabled; Bit 1: Manual scaling enabled
561	562	Float (32 bits, Little Endian)	Channel 1, Graph minimum	Bit 1 for this channel settings has to be set, in order to be used
563	564	Float (32 bits, Little Endian)	Channel 1, Graph maximum	Bit 1 for this channel settings has to be set, in order to be used
565	566	Float (32 bits, Little Endian)	Channel 2, Graph minimum	Bit 1 for this channel settings has to be set, in order to be used
567	568	Float (32 bits, Little Endian)	Channel 2, Graph maximum	Bit 1 for this channel settings has to be set, in order to be used
569	570	Float (32 bits, Little Endian)	Channel 3, Graph minimum	Bit 1 for this channel settings has to be set, in order to be used
571	572	Float (32 bits, Little Endian)	Channel 3, Graph maximum	Bit 1 for this channel settings has to be set, in order to be used
573	574	Float (32 bits, Little Endian)	Channel 4, Graph minimum	Bit 1 for this channel settings has to be set, in order to be used
575	576	Float (32 bits, Little Endian)	Channel 4, Graph maximum	Bit 1 for this channel settings has to be set, in order to be used
577	578	Float (32 bits, Little Endian)	Channel 5, Graph minimum	Bit 1 for this channel settings has to be set, in order to be used
579	580	Float (32 bits, Little Endian)	Channel 5, Graph maximum	Bit 1 for this channel settings has to be set, in order to be used
581	582	Float (32 bits, Little Endian)	Channel 6, Graph minimum	Bit 1 for this channel settings has to be set, in order to be used
583	584	Float (32 bits, Little Endian)	Channel 6, Graph maximum	Bit 1 for this channel settings has to be set, in order to be used
585	586	Float (32 bits, Little Endian)	Channel 7, Graph minimum	Bit 1 for this channel settings has to be set, in order to be used
587	588	Float (32 bits, Little Endian)	Channel 7, Graph maximum	Bit 1 for this channel settings has to be set, in order to be used
589	590	Float (32 bits, Little Endian)	Channel 8, Graph minimum	Bit 1 for this channel settings has to be set, in order to be used
591	592	Float (32 bits, Little Endian)	Channel 8, Graph maximum	Bit 1 for this channel settings has to be set, in order to be used
601	602	Float (32 bits, Little Endian)	Channel 1, Graph low alarm line	Note that this is only for the graph. The alarm status still has to be set. Write NaN to disable the line
603	604	Float (32 bits, Little Endian)	Channel 1, Graph low warning line	Note that this is only for the graph. The alarm status still has to be set. Write NaN to disable the line
605	606	Float (32 bits, Little Endian)	Channel 1, Graph high warning line	Note that this is only for the graph. The alarm status still has to be set. Write NaN to disable the line
607	608	Float (32 bits, Little Endian)	Channel 1, Graph high alarm line	Note that this is only for the graph. The alarm status still has to be set. Write NaN to disable the line
609	610	Float (32 bits, Little Endian)	Channel 2, Graph low alarm line	Note that this is only for the graph. The alarm status still has to be set. Write NaN to disable the line
611	612	Float (32 bits, Little Endian)	Channel 2, Graph low warning line	Note that this is only for the graph. The alarm status still has to be set. Write NaN to disable the line
613	614	Float (32 bits, Little Endian)	Channel 2, Graph high warning line	Note that this is only for the graph. The alarm status still has to be set. Write NaN to disable the line

615	616	Float (32 bits, Little Endian)	Channel 2, Graph high alarm line	Note that this is only for the graph. The alarm status still has to be set. Write NaN to disable the line
617	618	Float (32 bits, Little Endian)	Channel 3, Graph low alarm line	Note that this is only for the graph. The alarm status still has to be set. Write NaN to disable the line
619	620	Float (32 bits, Little Endian)	Channel 3, Graph low warning line	Note that this is only for the graph. The alarm status still has to be set. Write NaN to disable the line
621	622	Float (32 bits, Little Endian)	Channel 3, Graph high warning line	Note that this is only for the graph. The alarm status still has to be set. Write NaN to disable the line
623	624	Float (32 bits, Little Endian)	Channel 3, Graph high alarm line	Note that this is only for the graph. The alarm status still has to be set. Write NaN to disable the line
625	626	Float (32 bits, Little Endian)	Channel 4, Graph low alarm line	Note that this is only for the graph. The alarm status still has to be set. Write NaN to disable the line
627	628	Float (32 bits, Little Endian)	Channel 4, Graph low warning line	Note that this is only for the graph. The alarm status still has to be set. Write NaN to disable the line
629	630	Float (32 bits, Little Endian)	Channel 4, Graph high warning line	Note that this is only for the graph. The alarm status still has to be set. Write NaN to disable the line
631	632	Float (32 bits, Little Endian)	Channel 4, Graph high alarm line	Note that this is only for the graph. The alarm status still has to be set. Write NaN to disable the line
633	634	Float (32 bits, Little Endian)	Channel 5, Graph low alarm line	Note that this is only for the graph. The alarm status still has to be set. Write NaN to disable the line
635	636	Float (32 bits, Little Endian)	Channel 5, Graph low warning line	Note that this is only for the graph. The alarm status still has to be set. Write NaN to disable the line
637	638	Float (32 bits, Little Endian)	Channel 5, Graph high warning line	Note that this is only for the graph. The alarm status still has to be set. Write NaN to disable the line
639	640	Float (32 bits, Little Endian)	Channel 5, Graph high alarm line	Note that this is only for the graph. The alarm status still has to be set. Write NaN to disable the line
641	642	Float (32 bits, Little Endian)	Channel 6, Graph low alarm line	Note that this is only for the graph. The alarm status still has to be set. Write NaN to disable the line
643	644	Float (32 bits, Little Endian)	Channel 6, Graph low warning line	Note that this is only for the graph. The alarm status still has to be set. Write NaN to disable the line
645	646	Float (32 bits, Little Endian)	Channel 6, Graph high warning line	Note that this is only for the graph. The alarm status still has to be set. Write NaN to disable the line
647	648	Float (32 bits, Little Endian)	Channel 6, Graph high alarm line	Note that this is only for the graph. The alarm status still has to be set. Write NaN to disable the line
649	650	Float (32 bits, Little Endian)	Channel 7, Graph low alarm line	Note that this is only for the graph. The alarm status still has to be set. Write NaN to disable the line
651	652	Float (32 bits, Little Endian)	Channel 7, Graph low warning line	Note that this is only for the graph. The alarm status still has to be set. Write NaN to disable the line
653	654	Float (32 bits, Little Endian)	Channel 7, Graph high warning line	Note that this is only for the graph. The alarm status still has to be set. Write NaN to disable the line
655	656	Float (32 bits, Little Endian)	Channel 7, Graph high alarm line	Note that this is only for the graph. The alarm status still has to be set. Write NaN to disable the line
657	658	Float (32 bits, Little Endian)	Channel 8, Graph low alarm line	Note that this is only for the graph. The alarm status still has to be set. Write NaN to disable the line
659	660	Float (32 bits, Little Endian)	Channel 8, Graph low warning line	Note that this is only for the graph. The alarm status still has to be set. Write NaN to disable the line
661	662	Float (32 bits, Little Endian)	Channel 8, Graph high warning line	Note that this is only for the graph. The alarm status still has to be set. Write NaN to disable the line
663	664	Float (32 bits, Little Endian)	Channel 8, Graph high alarm line	Note that this is only for the graph. The alarm status still has to be set. Write NaN to disable the line
701		Integer (16 bits, Little Endian)	Date, year	
702		Integer (16 bits, Little Endian)	Date, month	
703		Integer (16 bits, Little Endian)	Date, day	
704		Integer (16 bits, Little Endian)	Time, hour	
705		Integer (16 bits, Little Endian)	Time, min	
706		Integer (16 bits, Little Endian)	Time, sec	
707		Integer (16 bits, Little Endian)	Timezone offset (min)	

RS-485 Connection

The RS-485 interface has to be connected via shielded data line with twisted pair wires. Each end of the bus segment needs to be connected to an termination of the bus wire. It is required to ensure a secure data transfer to the bus. Therefore a resistance (120Ω) must be switched between the line Data A-) and Data (+).

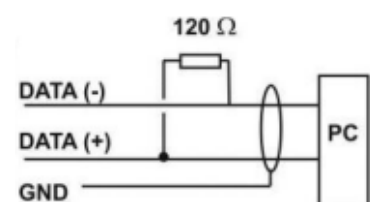

10 DEFAULT FACTORY SETTINGS:

Main Settings				
Language	English			
Screen layout	Horizontal [<i>landscape</i>]			
Visible screens	4			
Brightness Day (%)	100			
Brightness night (%)	10			
Auto Night Delay (min.)	0 [<i>Off</i>]			
Pincode	Disabled			
Access Point SSID	Pedak			
Access Point Password	Pedak1234			
Access Point	enabled			
Buzzer Frequency	Normal			
Panel Settings	Panel 1:	Panel 2:	Panel 3:	Panel 4:
Name	"Temperature"	"Humidity"	"Pressure"	"Pressure"
Room name	"Room 1"	"Room 1"	"Room 1"	"Room 2"
Unit	"°C"	"%"	"Pa"	"Pa"
Channel	Analog 1	Analog 2	Analog 3	Analog 4
Background colour	White	White	White	White
Number of decimals	1	1	1	1
File Logging Enabled	On	On	On	On
Toggle panel	Off	Off	Off	Off
Relay index	0 [<i>no relay</i>]	0 [<i>no relay</i>]	0 [<i>no relay</i>]	0 [<i>no relay</i>]
Is Disable Enabled	Off [<i>disabled</i>]	Off [<i>disabled</i>]	Off [<i>disabled</i>]	Off [<i>disabled</i>]
Disable Channel Name	off	off	off	off
Disable Text	[<i>empty</i>]	[<i>empty</i>]	[<i>empty</i>]	[<i>empty</i>]
Alarm Channel Enabled	off	off	off	off
Alarm Channel Delay	0 [<i>no delay</i>]	0 [<i>no delay</i>]	0 [<i>no delay</i>]	0 [<i>no delay</i>]
Acquisition	[<i>Analog 1</i>]	[<i>Analog 2</i>]	[<i>Analog 3</i>]	[<i>Analog 4</i>]
Input	4...20mA	4...20mA	4...20mA	4...20mA
Input Range	0...100	0...100	0...100	0...100
Smoothing	98.06	98.06	98.06	98.06
Graphical data				
Manual Scaling Enabled	On	On	On	On
Minimum	0	0	0	0
Maximum	100	100	100	100
Modbus RS485 Client				
Baud Rate	115200			
Data Bits	8			
Parity	None			
Stop bits	1			
Address	1			

11 Menu Layout:

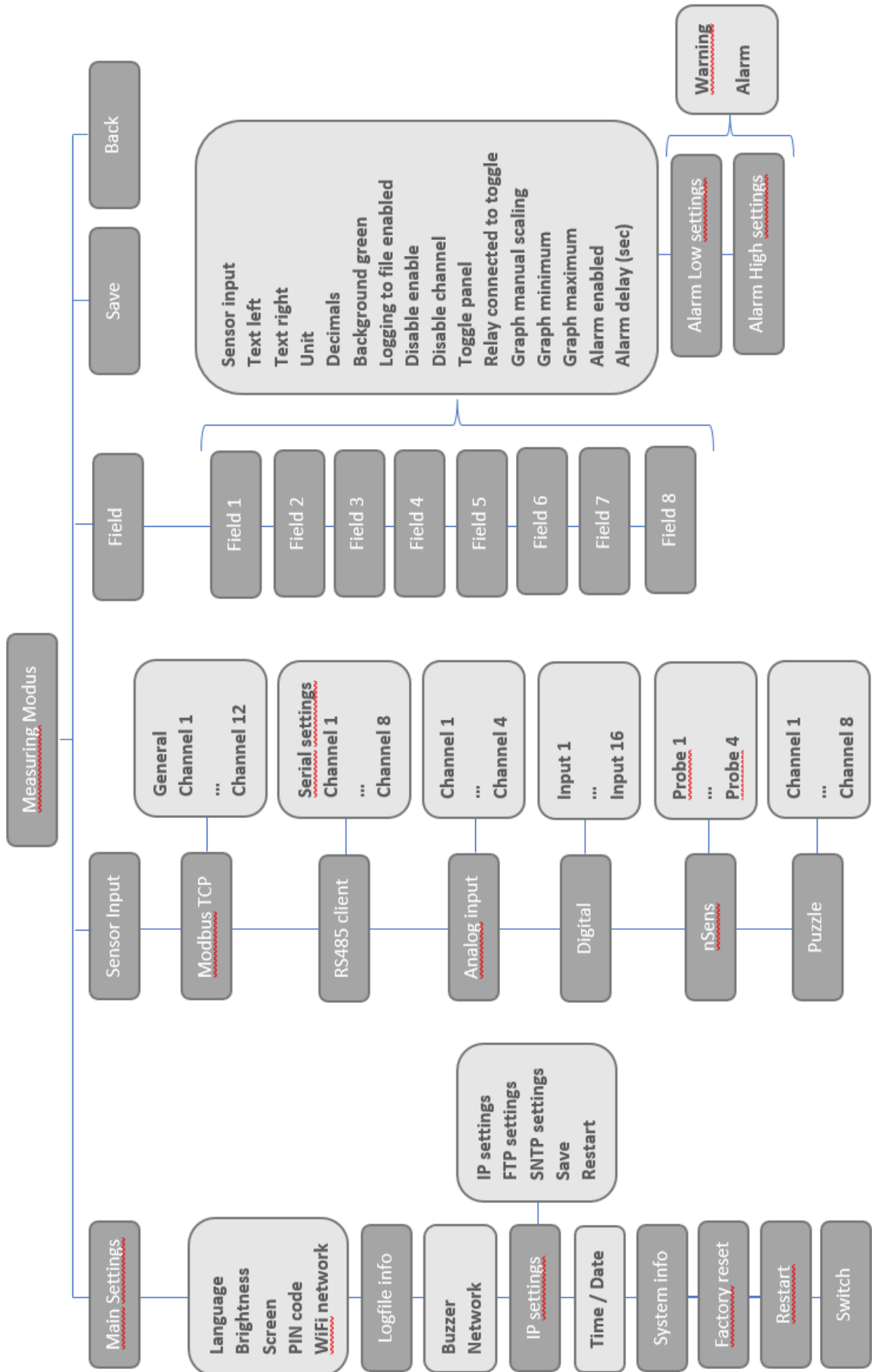

12 SCREEN LAYOUT:

Horizontal

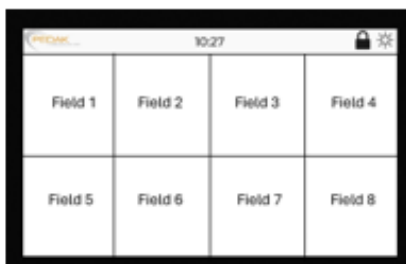
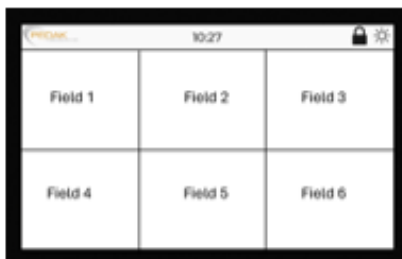
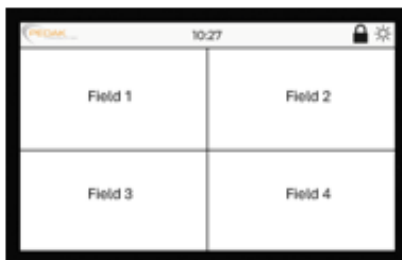
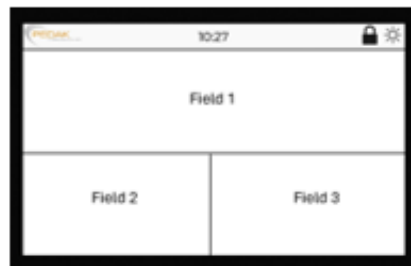
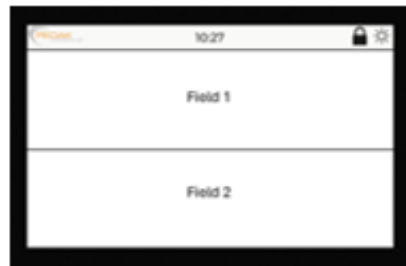

Vertical

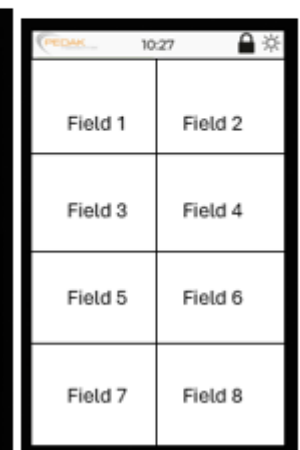
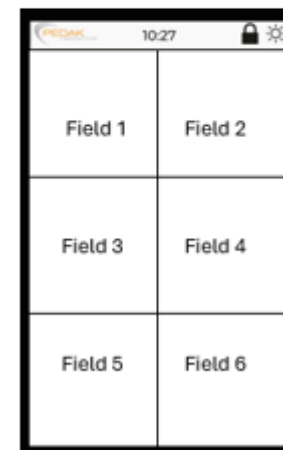
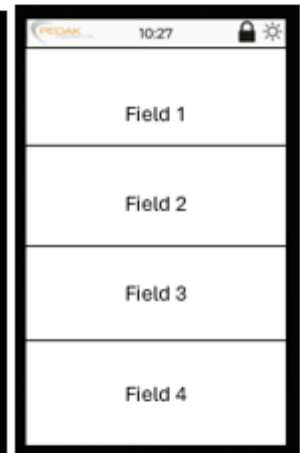
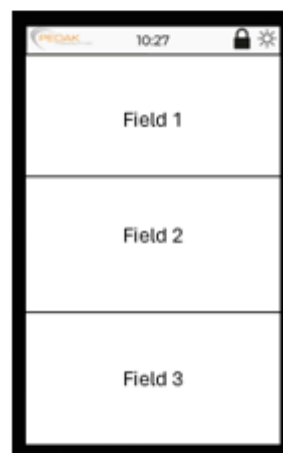
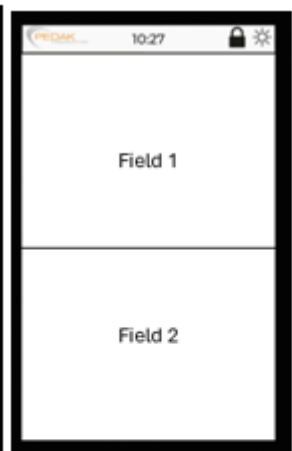
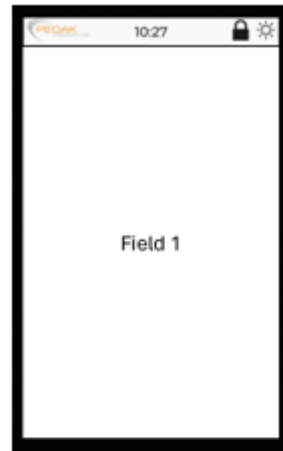

13 TROUBLE SHOOTINGS:

Display Message	Problem	Solution
(No message)	Display and/or PRIO-box does not turn ON	Check if the power supply is connected and check the polarity
Error 1	“Channel unknown” A channel has been set that not or no longer exists. Or the channel name has been changed but not in the readout (“Field” menu)	Check channel and/or channel settings
Error 2	“Probe error” nLink/nSens/Modbus client	Check the nLink/nSens sensor or the Modbus-485 signal
Error 3	“Connection lost” Time out for Mdbus-485 or nLink/nSens	Check communication signal or connection cable
Error 4	“Signal not updated” No new data has been received since the screen is loaded. This message should disappear automatically.	Update the Modbus signal or check the Modbus connection
Error 5	“Other error” Under normal circumstances, this should never appear. If it does appear, a factory reset is recommended because something is wrong with the configuration.	Check the configuration. If the problem does not disappear please send a copy of the settings to your dealer for analyses.
File too short	Software failure	Display needs to be returned to Pedak
User code exit	Wrong SD-card	Install the supplied SD-card
Storage error: Media error	No SD-card is installed	Install the supplied SD-card
(no message)	Modbus failure	No 120Ω resistor is used
(no message)	Modbus failure	To many displays in one Modbus line. @RS-485 this is approx. 32 displays depending on the quality (electrical load) of the network. @TCP/IP it is in theory “unlimited” on a class A network and max. 100m cable length and using the correct peripheral equipment (router, etc.)
(no message)	Modbus failure	Check Modbus settings

13 EXPANSION MODULES:

The PRIObx has standard 4 analogue inputs, 2 digital inputs and 2 relays but this can be expanded with 8 extra analogue or digital inputs [NOTE: only 8 channels can be displayed at once] and/or 4 relays.

For this expansion you need Puzzle Modules.

This expansion modules need to be connected to the PRIObx.

In the expansion module you choose the input cards you prefer (0-5V / 0-10V / 0-20mA, Digital / ...)

💡 Ask your dealer for the possibilities.

The relay module has 4 relays [230VAC – 10A / 24VDC – 10A]

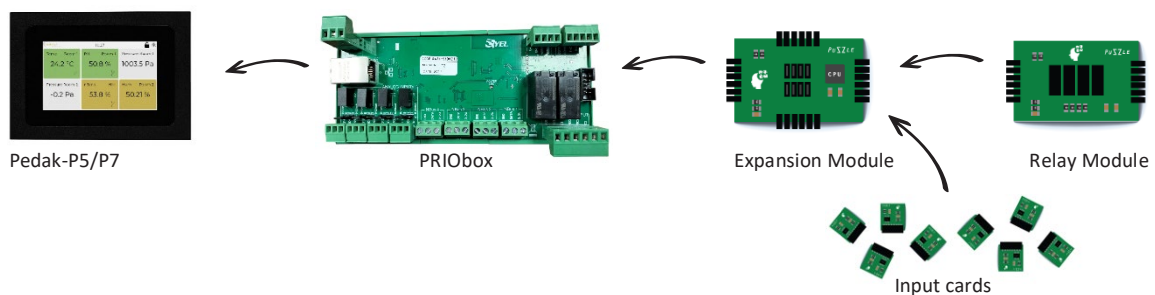

14 ORDERING CODES:

Item:	Order code:	Description:
P5 Display	PEDAKP5	5" Display incl. wall box
P7 Display	PEDAKP7	7" Display incl. wall box
PRIObx	PRIOBOX	Input / output box for Pedak-P5 or P7
Wall box P5	WALLBOXP5	Spare wall box for Pedak-P5 display (5")
Wall box P7	WALLBOXP7	Spare wall box for Pedak-P7 display (7")
Puzzle-Master-IO	PUMASIO	Puzzle Master IO module (excl. analogue input cards)
0-10V Input card	PU10VINP	0-10V analogue input card (for Puzzle-IO)
0-5V Input card	PU05VINP	0-5V analogue input card (for Puzzle-IO)
0-20mA Input card	PU20MAINP	0-20mA analogue input card (for Puzzle-IO)
Relay Module	PURELAY	4x Relay (230VAC – 10A / 24VDC – 10A) [Priobox needed]



Pedak meettechniek

Roorveld 1
6093 PL Heythuysen (NL)
T +31 (0)475 49 74 24
E info@pedak.nl



www.pedak.nl