

Infrared thermometers

Infrared video thermometers

Ratio pyrometer

Infrared cameras

Accessories / software / apps

PRODUCT OVERVIEW

Non-contact temperature measurement

Made in Germany

when temperature matters



Spot measurement or thermal image?

First of all, it is important to define the measurement task and to decide on one of these two measures:

Which measure?

A **point measuring infrared thermometer** should be used if you know where the critical point or the area to be measured is positioned within your application. The size of the measuring object is important to define which lens is necessary. It is therefore possible to monitor the accurate temperature and optimize processes – if necessary – before quality problems arise.

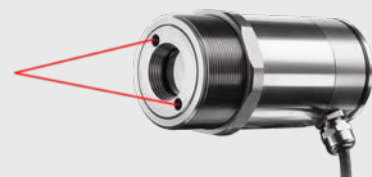

i Pyrometer configurator:

www.optris.global/pyrometer-configurator

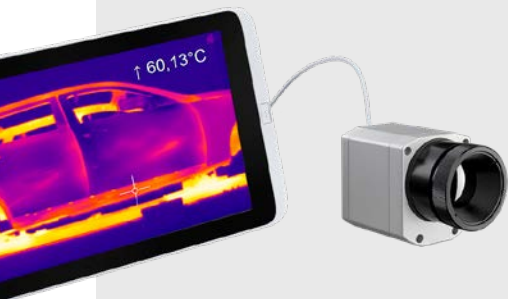

Infrared cameras should be used in cases where more than one critical area exists or the area cannot be clearly defined. Critical areas can be localized by the camera through the demonstration of thermal images. The areas can then be permanently monitored by one or multiple fixed infrared thermometers.

i IR-camera-configurator:

www.optris.global/ir-camera-configurator

Which object surface?

The condition of the object surface defines the measurement device and wavelength to be used for the application. The **emissivity ϵ** occupies a central position. The choice of the right device is of great importance especially for metals, where the emissivity depends on the temperature and wave length.

We are able to offer appropriate measurement devices for most applications throughout a wide product range.

The following explanation helps to find the right **wavelength** for your application:

- **8 – 14 μm**
for non-metal surfaces
(Type of device: LT)
- **0.5; 1.0; 1.6; 2.3 μm**
mainly for liquid metals and metal surfaces
(Type of device: 05M; 08M; 1M; 2M; 3M; 4M)
- **3.43 μm**
for thin plastic films like PE, PP and PS
(Type of device: P3)
- **3.9 ; 4.24; 4.64 μm**
for special applications
(Type of device: MT; F2; F6)
- **5.0 μm**
for glass surfaces (Type of device: G5)
- **7.9 μm**
for plastic foils and glass surfaces
(Type of device: P7 / G7)

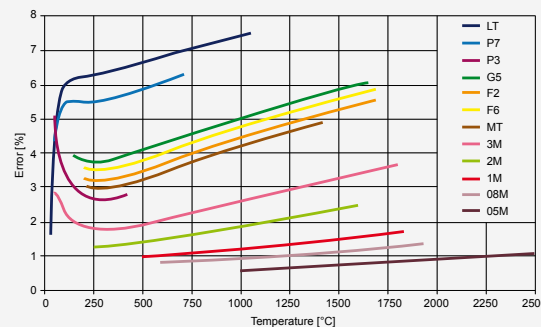

Short wavelengths reduce measurement errors on surfaces with low, unknown or changing emissivity. This occurs mostly with metals. The diagram above shows the measurement errors across different wavelengths if the emissivity is wrongly adjusted by only 10 percent.

Which temperature range?

The temperature is another factor to decide on. The range should cover all relevant temperatures of the application. The measurement range of the devices is between **-50 °C and 3000 °C**.

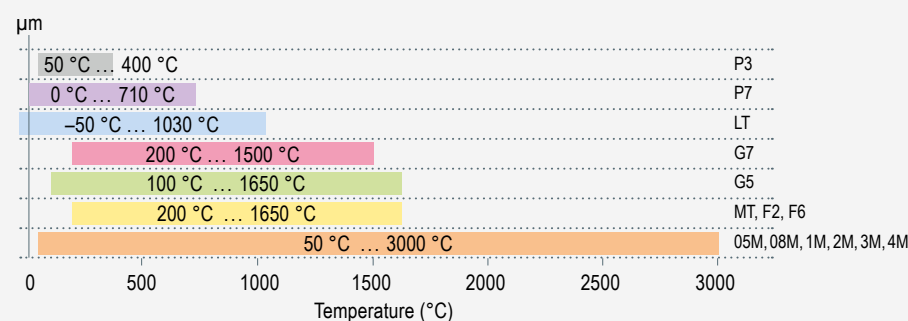

Display of temperature over wavelength for the devices of the compact and the high performance series

Which process velocity?

To achieve accurate temperature measurement it is important to know how fast measuring objects are moving in front of the sensor or how fast they change temperature.

Our fastest infrared thermometer captures changes within **1 ms**.

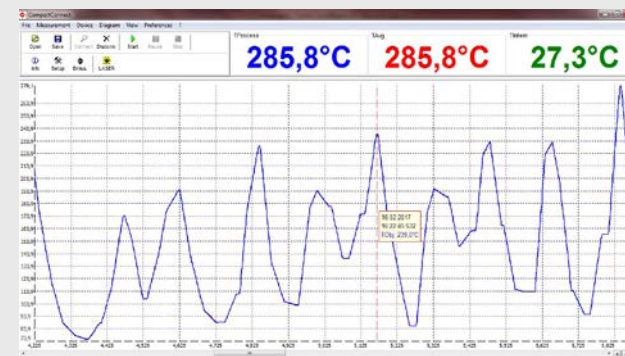

Display of fast temperature changes over a period of time.

Integration of sensors?

Our temperature sensors can be installed as part of the process with **mounting brackets** or **flanges**.

Depending on the device, we offer different analog and digital interfaces for **data evaluation** such as triggering, alerting or saving of data.

Analog Interfaces:
0 – 20 mA, 4 – 20 mA, 0 – 5 V, 0 – 10 V,
Thermocouple (type J, type K)

Digital Interfaces:
USB, RS232, RS485, Relay, Profibus DP, Modbus RTU,
Ethernet

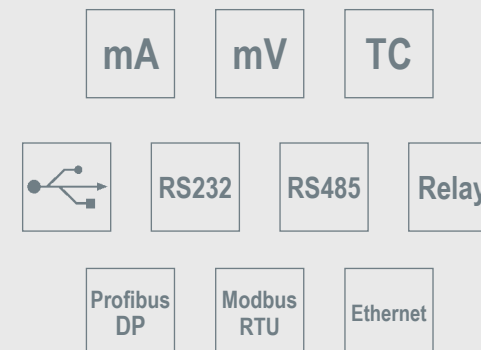

Object size and measurement distance

IR thermometers use the radiation signal emitted by the entire measurement spot. The size of the measurement spot (S) largely depends on the device, the optics selected and the distance between the sensor and measurement object plane (D):

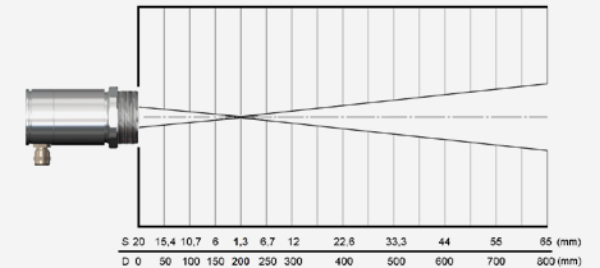

Measurement spot diameter (S) depending on the measurement distance (D) with an IR thermometer

For a precise temperature measurement, the measurement spot needs to be smaller than, or the same size as the object to be measured.

If the measurement spot is larger than the object, a temperature is calculated from the averaged heat radiation signal from the object and its environment. In a colder environment, it means that correspondingly, the temperature measurement value determined is too low.

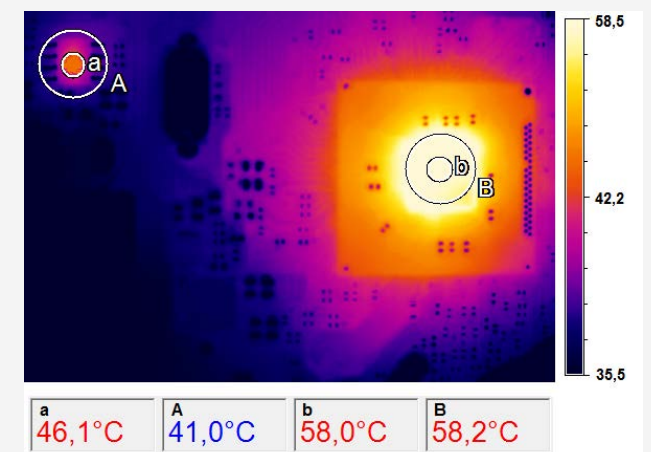

IR image of an electronics circuit board – adaptation of the measurement spot to the object size

When transferred to the two-dimensional measurement with IR cameras, the pixel size there needs to suit the object size for the selected measurement distance. Here, the object should fill at least 3x3 pixels.

In the example above, the correct temperature of a chip of 46 °C is determined with the suitable measurement spot size (a). A measurement spot (A) which is three times larger already leads to a measurement error of 5 °C or 10%. If you select a larger component on the same circuit board (on the right in the picture), then in this case, both measurement spots (b and B) provide the correct temperature measurement value of 58 °C.

Infrared thermometers

Small, compact infrared thermometers, ideal for use in cramped and hot surroundings



CS series

Single-piece pyrometer - Electronic within sensing head

In this device design, the optics are installed together with the electronics in a compact housing.



CSmicro series

Single-piece pyrometer - Electronic within cable

To increase the robustness of the sensor head, Optris developed two-wire devices whose electronics are integrated into the cable. This makes the IR sensor, for example, significantly less sensitive to heat. In addition, the heat generated by the two-wire electronics has no influence on the thermal stability of the sensor head.



CT series

Two-piece pyrometer - Sensing head with separate electronic box





As a third variant, a two-part device consisting of measuring head and separate electronics box is available. In addition to the simple device configuration and a temperature display, the electronics box offers the possibility to choose between different interfaces, such as USB, RS232, RS485, Modbus RTU, Profibus DP and Ethernet.

Infrared thermometers CS/ CSmicro series					
Basic model	CS	CSmicro	CSmicro	CSmicro	CSmicro
Type	LT	LT02 / LT15 (H) / LT 22 H	LT15 HS	2M	3M
Classification / special features	Single-piece sensor with smart LED display (self diagnostics, aiming support, alarm, temperature code)	Single-piece sensor with electronics in cable; smart LED display	Single-piece two-wire sensor with electronics in cable; high thermal sensitivity; smart LED display	Single-piece sensor for temp. measurements on metal ; electronics in cable; smart LED display	Single-piece sensor for temp. measurements on metal ; electronics in cable; smart LED display
Detector	Thermopile	Thermopile	Thermopile	InGaAs	Ext. InGaAs
Sensing head exchangeable	-	-	-	-	-
Head cable shortening	■	■ (behind electronics)	■ (behind electronics)	■ (behind electronics)	■ (behind electronics)
Thread (sensing head)	M12x1	M12x1	M18x1	M12x1	M12x1
Spectral range	8–14 µm	8–14 µm	8–14 µm	1.6 µm	2.3 µm
Temperature ranges	-50 ... 1030 °C	-50 ... 1030 °C	-20 ... 150 °C	2ML: 250 ... 800 °C 2MH: 385 ... 1600 °C	3ML: 50 ... 350 °C 3MH: 100 ... 600 °C
Temperature resolution	0.1 K	0.1 K	0.025 K [>20 °C]	0.1 K	0.1 K
Optical resolution	15:1	LT02: 2:1 / LT15 (H): 15:1 / LT22 H: 22:1	15:1	2ML: 40:1 2MH: 75:1	3ML: 22:1 3MH: 33:1
Option: CF lens	■	■	■	■	■
Smallest spot (CF optics / add. CF lens)	0.8 mm @ 10 mm	LT02: 2.5 mm @ 23 mm LT15 (H): 0.8 mm @ 10 mm LT 22 H: 0.6 mm @ 10 mm	0.8 mm @ 10 mm	2ML: 2.7 mm @ 110 mm 2MH: 1.5 mm @ 110 mm	3ML: 1.5 mm @ 30 mm 3MH: 1 mm @ 30 mm
Smallest spot (SF optics)	7 mm	7 mm	7 mm	7 mm	7 mm
Sighting	LED aiming	LED aiming	LED aiming	LED aiming	LED aiming
Response time (90 %)	25 ms	LT: 14 ms / LTH:150 ms	150 ms	8 ms (mA version: 20 ms)	8 ms (mA version: 20 ms)
Accuracy	±1.5 °C or ±1.5 %	±1 °C or ±1 %	±1 °C or ±1 %	±(0.3% T _{Meas} +2 °C)	±(0.3% T _{Meas} +2 °C)
Outputs analog: 0–20 mA / 4–20 mA / 0–5 V / 0–10 V / t/c (K/J)	- / - / ■ / ■ / ■	- / - / ■ / ■ / - or - / ■ / - / - / -	- / - / ■ / ■ / - or - / ■ / - / - / -	- / - / ■ / ■ / - or - / ■ / - / - / -	- / - / ■ / ■ / - or - / ■ / - / - / -
Second analog output	-	-	-	-	-
Interfaces: USB / RS232 / RS485 / Profibus / Ethernet / Modbus RTU / Relay	■ / - / - / - / - / - / -	■ / - / - / - / - / - / -	■ / - / - / - / - / - / -	■ / - / - / - / - / - / -	■ / - / - / - / - / - / -
Signal processing: Peak / Valley / AVG / Advanced hold	■ / ■ / ■ / ■	■ / ■ / ■ / ■	■ / ■ / ■ / ■	■ / ■ / ■ / ■	■ / ■ / ■ / ■
T _{Amb} Head min.	-20 °C	-20 °C	-20 °C	-20 °C	-20 °C
T _{Amb} Head max.	80 °C	LT02 / LT15: 120 °C LT15 H / LT22 H: 180 °C	75 °C	125 °C	85 °C
T _{Amb} Electronics max.	80 °C	80 °C / 75 °C (mA version)	80 °C / 75 °C (mA version)	80 °C / 75 °C (mA version)	80 °C / 75 °C (mA version)
Functional inputs/ number	■ / 1	■ / 1	■ / 1	■ / 1	■ / 1
External emissivity adjustment	■ (via V _{cc} adjust)	■ (mV version)	■ (mV version)	■ (mV version)	■ (mV version)
External background temperature control	■	■ (mV version)	■ (mV version)	■ (mV version)	■ (mV version)
Trigger input for reset of hold functions	■	■	■	■	■
Digital I/O pins/ number	-	-	-	-	-
Simultaneous analog and digital output	-	■ (mA version only)	■ (mA version only)	■ (mA version only)	■ (mA version only)
Alarm output as an alternative to analog output	■	■	■	■	■
Additional alarm output/ switching output	■	■	■	■	■
Voltage supply	5–30 V DC	5–30 V DC	5–30 V DC	5–30 V DC	5–30 V DC
Standard cable length	1 m	0.5 m + 0.5 m	0.5 m + 0.5 m	0.5 m + 0.5 m	0.5 m + 0.5 m
Cable length options	3 / 8 / 15 m	Options up to 9 m	Options up to 9 m	Options up to 9 m	Options up to 9 m

Basic model	CT	CTfast	CThot	CT	CT	CT	CT	CT
Type	LT02 / LT15 / LT22	LT15F / LT25F	LT02H / LT10H	1M / 2M	3M	4M	G5	P3 / P7
Classification / special features	Two-piece sensor with separate electronic box incl. programming keys and display	Two-piece sensor with fast response time and separate electronic box incl. programming keys and display	Two-piece sensor for hot surroundings with separate electronic box incl. programming keys and display	Two-piece sensor for high temp. meas. of metal with separate electronic box incl. programming keys and display	Two-piece sensor for low temp. meas. of metal with separate electronic box incl. programming keys and display	Two-piece sensor for low temp. and high speed meas. with separate electronic box incl. programming keys and display	Two-piece sensor for temp. meas. of glass with separate electronic box incl. programming keys and display	Two-piece sensor for temp. meas. on thin plastic film and glass (P7) with separate electronic box incl. programming keys and display
Detector	Thermopile	Thermopile	Thermopile	1M: Si / 2M: InGaAs	Erweiterter InGaAs	InAsSb	Thermopile	Thermopile (P7)
Sensing head exchangeable	■	–	■	■	■	–	■	–
Head cable shortening	■ [–0.1 K/m]	■ [max. 3 m]	■ [–0.1 K/m]	■ [max. 3 m]	■	■	■ [–0.1 K/m]	–
Thread (sensing head)	M12x1	M12x1	M18x1	M12x1	M12x1	M12x1	M12x1	M18x1
Spectral range	8–14 µm	8–14 µm	8–14 µm	1M: 1.0 µm / 2M: 1.6 µm	2.3 µm	2.2–6 µm	5.0 µm	P3: 3.43 µm / P7: 7.9 µm
Temperature ranges	LT02: –50 ... 600 °C LT15: –50 ... 600 °C LT22: –50 ... 975 °C	–50 ... 975 °C	–40 ... 975 °C	1M: 485 ... 1050 °C 1MH: 650 ... 1800 °C 1MH1: 800 ... 2200 °C 2M: 250 ... 800 °C 2MH: 385 ... 1600 °C 2MH1: 490 ... 2000 °C	L: 50 ... 400 °C H: 100 ... 600 °C H1: 150 ... 1000 °C H2: 200 ... 1500 °C H3: 250 ... 1800 °C	0 °C ... 500 °C	L: 100 ... 1200 °C H: 250 ... 1650 °C	P3: 50 ... 400 °C P7: 0 ... 710 °C
Temperature resolution	0.1 K	LT15F: 0.2 K / LT25F: 0.4 K	0.25 K	0.1 K	0.1 K	0.1 K	L: 0.1 K / H: 0.2 K	P3: 0.1 K / P7: 0.5 K
Optical resolution	LT02: 2:1 / LT15: 15:1 / LT22: 22:1	LT15F: 15:1 LT25F: 25:1	LT02H: 2:1 LT10H: 10:1	L: 40:1 H: 75:1	L: 22:1 / H: 33:1 / H1–H3: 75:1	10:1	L: 10:1 H: 20:1	P3: 15:1 P7: 10:1
Option: CF lens	■	■	■	■	■	■	–	–
Smallest spot (CF optics/ add. CF lens)	LT02: 2.5 mm @ 23 mm LT15: 0.8 mm @ 10 mm LT22: 0.6 mm @ 10 mm	0.5 mm @ 8 mm	LT02H: 2.5 mm @ 23 mm LT10H: 1.2 mm @ 10 mm	1.5 mm @ 110 mm	3.4 mm @ 110 mm	5.0 mm @ 50 mm	–	P7: 1.2 mm @ 10 mm
Smallest spot (SF optics)	7 mm	7 mm	7 mm	7 mm	7 mm	7 mm	7 mm	7 mm
Sighting	–	–	–	–	–	–	–	–
Response time (90%)	150 ms (95%)	LT15F: 9 ms / LT25F: 6 ms	100 ms	1 ms	1 ms	300 µs (90 µs exposure time)	L: 120 ms / H: 80 ms	P3: 100 ms / P7: 150 ms
Accuracy	±1 °C or ±1%	±2 °C or ±1%	±1.5 °C or ±1%	±(0.3% T _{Meas} + 2 °C)	±(0.3% T _{Meas} + 2 °C)	±(0.3% T _{Meas} + 2 °C)	±2 °C or ±1%	P3: ±3 °C or ±1% P7: ±1.5 °C or ±1%
Outputs analog: 0–20 mA / 4–20 mA / 0–5 V / 0–10 V / t/c (K/J)	■ / ■ / ■ / ■	■ / ■ / ■ / ■	■ / ■ / ■ / ■	■ / ■ / ■ / ■	■ / ■ / ■ / ■	■ / ■ / ■ / ■	■ / ■ / ■ / ■	■ / ■ / ■ / ■
Second analog output	■	■	■	–	–	■	■	■
Interfaces: USB / RS232 / RS485 / Profibus / Ethernet / Modbus RTU / Relay	■ / ■ / ■ / ■ / ■ / ■	■ / ■ / ■ / ■ / ■ / ■	■ / ■ / ■ / ■ / ■ / ■	■ / ■ / ■ / ■ / ■ / ■	■ / ■ / ■ / ■ / ■ / ■	■ / ■ / ■ / ■ / ■ / ■	■ / ■ / ■ / ■ / ■ / ■	■ / ■ / ■ / ■ / ■ / ■
Signal processing: Peak / Valley / AVG / Advanced hold	■ / ■ / ■ / ■	■ / ■ / ■ / ■	■ / ■ / ■ / ■	■ / ■ / ■ / ■	■ / ■ / ■ / ■	■ / ■ / ■ / ■	■ / ■ / ■ / ■	■ / ■ / ■ / ■
T_{Amb} Head min.	–20 °C	–20 °C	–20 °C	–20 °C	–20 °C	0 °C	–20 °C	P3: 0 °C / P7: –20 °C
T_{Amb} Head max.	LT02: 130 °C LT15/LT22: 180 °C	120 °C	250 °C	1M: 100 °C 2M: 125 °C	85 °C	70 °C	85 °C	P3: 75 °C / P7: 85 °C
T_{Amb} Electronics max.	85 °C	85 °C	85 °C	85 °C	85 °C	70 °C	85 °C	P3: 75 °C / P7: 85 °C
Functional inputs/ number	■ / 3	■ / 3	■ / 3	■ / 3	■ / 3	– / –	■ / 3	■ / 3
External emissivity adjustment	■	■	■	■	■	■	■	■
External background temperature control	■	■	■	■	■	■	■	■
Trigger input for reset of hold functions	■	■	■	■	■	■	■	■
Digital I/O pins/ number	–	–	–	–	–	■ (via I/O pins)	–	–
Simultaneous analog and digital output	■	■	■	■	■	■	■	■
Alarm output as an alternative to analog output	■	■	■	■	■	■	■	■
Additional alarm output/ switching output	■	■	■	■	■	■ (via I/O pins)	■	■
Voltage supply	8–36 V DC	8–36 V DC	8–36 V DC	8–36 V DC	8–36 V DC	8–30 V DC / 5 V USB / max. 1.2 W	8–36 V DC	8–36 V DC
Standard cable length	1 m	1 m	3 m	3 m	3 m	3 m	3 m	3 m
Cable length options	3 / 8 / 15 m	3 / 8 / 15 m	8 / 15 m	8 / 15 m	–	8 / 15 m	8 / 15 m	P3: 8 m / P7: 8 m, 15 m

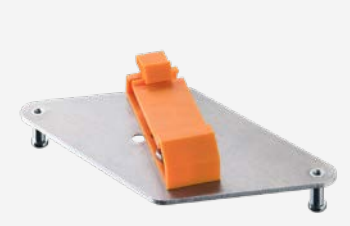

Accessories CS/ CSmicro/ CT series

CTex LT + CTex LT hot	Mechanical accessories		
OPTCTEX	ACCTFB / ACCTFBMH / ACCTFB2	ACCTTAS	ACCTKF40B270 / ACCTKF40GE
<p>Aluminum housing with mounting device to accommodate the Zener barriers (top-hat rail) and the CT electronics</p> <p>Advantage</p> <ul style="list-style-type: none"> Two-piece measuring system with active electronic for evaluation and passive IR receiver (sensing head) CTex sensing head can be installed as passive element in hazardous areas Energy limitation with appropriate zener barriers (STAHL) with approval for zone 1 (PTB 01 ATEX 2053/ E II (1/2) GD [Ex ia/ib] IIC/IIIB) 	<p>Mounting bracket, adjustable in one axis (M12x1 sensing head, massive housing, mounting of CT sensing head + Laser-Sightingtool)</p> 	<p>Tilt assembly for heads with optical resolution $\geq 10:1$</p> 	<p>KF40 flange for CT1M, 2M, 3M with B270 window (up to 10-7 mbar) / KF40 flange for CTLT with Ge window (up to 10-7 mbar)</p> 
	ACCTRAIL	ACCTMB	ACCTMG
	<p>Rail mount adapter for CT electronics</p> 	<p>Mounting bolt with thread M12x1</p> 	<p>Mounting fork, adjustable in 2 axes, with thread M12x1</p> 

Optical accessories		
ACCTCF / ACCTPW	ACCTCFE / ACCTPWE	D08ACCTLST / ACCTOEMLST
<p>CF-lens or protective window (for LT) for M12x1 sensing head ACCTCFHT / ACCTPWHT for 1M, 2M, 3M</p> 	<p>CF-lens or protective window (for LT) with external thread for air purge or massive housing ACCTCFHTE / ACCTPWHTE for 1M, 2M, 3M</p> 	<p>Laser-Sightingtool (for CT)/ OEM Laser-Sightingtool, 635 nm, rotation symmetrical, for connection to CT electronics, power supply via CT electronic box or battery</p> 
ACCTRAM	ACCTPA + ACCTST20 (20 mm length) / ACCTST40 (40 mm length) / ACCTST88 (88 mm length)	
<p>Right angle mirror for measurements 90° to the sensor axis for sensing heads with optical resolution $\geq 10:1$</p> 	<p>Pipe adapter with M12x1 internal thread + Sighting tube with M12x1 external thread</p> 	

Air purges and protective housings			
ACCSAP	ACCTAPMH	Massive housing of:	
<p>Air purge collar (for heads with optical resolution $\geq 10:1$)</p> 	<p>Air purge collar for Massive housing (D06) / CSmicro HS / CThot / CT P3 / CT P7</p> 	<ul style="list-style-type: none"> stainless steel (D06ACCTMHS) compact, brass (D06ACCTMHB) anodized aluminium (D06ACCTMHA) 	<ul style="list-style-type: none"> stainless steel version with CF optics (D06ACCTMHSCF) stainless steel version for HT CF optics (D06ACCTMHSCFHT)
ACCTAPLCFHT	ACCTAPL	ACCTAP / ACCTAP2 (2:1 optics)	
<p>Air purge collar, laminar, with integrated CF lens (for 1M / 2M / 3M)</p> 	<p>Air purge collar, laminar</p> 	<p>Air purge for CT heads (not for heads with 32 mm length)</p> 	

Combinations					
ACCTAPL	ACCTMG		ACCTFB2	D08ACCTLST/ACCTOEMLST	
<p>Air purge collar, laminar</p> 	<p>Mounting fork</p> 	<p>=</p> 	<p>Mounting bracket for sensing head + Sighting tool</p> 	<p>OEM Laser-Sightingtool</p> 	<p>Sensing head with Laser-Sighting tool</p> 
ACCTFB	ACCTMB	ACCTAB	D06ACCTAPMH	ACCTAPMH	
<p>Mounting bracket for M12x1 sensing head</p> 	<p>Mounting bolt</p> 	<p>=</p> 	<p>Massive housing, stainless steel</p> 	<p>Airpurge, stainless steel</p> 	<p>Massive housing with air purge</p> 

Infrared thermometers

with highest optical resolution and double laser



CSlaser series

Single-piece - Electronic within sensing head

Probably the most space-saving design is the one-piece measuring head. Optics and electronics are built into one compact device.

CTlaser series

Two-piece - Sensing head and separate electronic box

The two-part thermometer design consists of the measuring head and separate electronics box. In addition to easy device configuration and a temperature display, the electronics box offers the possibility to choose between different interfaces, such as USB, RS232, RS485, Modbus RTU, Profibus DP and Ethernet.

Ratio pyrometer

In metallurgy, a high emission of dust, smoke or vapor often cannot be avoided. A ratio thermometer ensures a reliable temperature measurement of melts or metallic surfaces even under these adverse conditions. The CTratio provides constant measurement results even with a partially dirty lens or for objects that move within the measurement area (e.g. metal rods or wires).



Basic model	CSlaser	CSlaser	CSlaser
Type	LT / hs LT	2M	G5
Classification / special features	Single-piece two-wire sensor with electronics in sensing head	Single-piece two-wire sensor with electronics in sensing head for measurement of metal	Single-piece two-wire infrared thermometer for temperature measurement of glass
Detector	Thermopile	InGaAs	Thermopile
Sensing head exchangeable	-	-	-
Head cable shortening	■	■	■
Thread (sensing head)	M48x1.5	M48x1.5	M48x1.5
Spectral range	8–14 µm	1.6 µm	5.0 µm
Temperature ranges	LT: -30 ... 1000 °C hs LT: -20 ... 150 °C	L: 250 ... 800 °C H: 385 ... 1600 °C	HF: 200 ... 1450 °C H1F: 250 ... 1650 °C
Temperature resolution	LT: 0.1 K / hs LT: 0.025 K	0.1 K	0.1 K
Optical resolution	50:1	2MH: 300:1 2ML: 150:1	HF / H1F: 45:1
Option: CF lens	-	-	-
Smallest spot (CF optics/ add. CF lens)	1.4 mm @ 70 mm	0.5 mm @ 150 mm	1.6 mm @ 70 mm
Smallest spot (SF optics)	24 mm @ 1200 mm	3.7 mm @ 1100 mm	27 mm @ 1200 mm
Sighting	Double laser	Double laser	Double laser
Response time (90 %)	150 ms	10 ms	HF / H1F: 30 ms
Accuracy	±1 °C or ±1 %	±(0.3% T _{Meas} +2 °C)	±1.5 °C or ±1 %
Outputs analog: 0–20 mA / 4–20 mA / 0–5 V / 0–10 V / t/c (K/J)	- / ■ / - / - / -	- / ■ / - / - / -	- / ■ / - / - / -
Second analog output	-	-	-
Interfaces: USB / RS232 / RS485 / Profibus / Ethernet / Modbus RTU / Relay	■ / - / - / - / - / - / -	■ / - / - / - / - / - / -	■ / - / - / - / - / - / -
Signal processing: Peak / Valley / AVG / Advanced hold	■ / ■ / ■ / ■	■ / ■ / ■ / ■	■ / ■ / ■ / ■
T_{Amb} Head min.	-20 °C	-20 °C	-20 °C
T_{Amb} Head max.	85 °C	85 °C	85 °C
T_{Amb} Electronics max.	85 °C	85 °C	85 °C
Functional inputs/ number	- / -	- / -	- / -
External emissivity adjustment	-	-	-
External background temperature control	-	-	-
Trigger input for reset of hold functions	-	-	-
Digital I/O pins/ number	-	-	-
Simultaneous analog and digital output	■	■	■
Alarm output as alternative to analog output	■	■	■
Additional alarm output/ switching output	■	■	■
Voltage supply	5–30 V DC	5–30 V DC	5–30 V DC
Standard cable length	3 m	3 m	3 m
Cable length options	8 / 15 m	8 / 15 m	8 / 15 m

1) At object temperatures >0 °C, ε = 1

Basic model	CTlaser	CTlaser	CTlaser	CTlaser	CTlaser	CTlaser	CTlaser	CTlaser	CTlaser	CTratio	
Type	LT / LTF	05M	1M / 2M	3M	4M	MT / F2 / F6	G5	G7	P7	1M / 2M	
Classification / special features	Two-piece sensor with separate electronic box with fast response time, incl. programming keys and display	Two-piece sensor with separate electronic box for high temp. measurement of liquid metal, incl. programming keys and display	Two-piece sensor with separate electronic box for high temp. measurement of metal, incl. programming keys and display	Two-piece sensor with separate electronic box for low temp. measurement of metal, incl. programming keys and display	Two-piece sensor for low temp. and high speed meas. with separate electronic box incl. programming keys and display	Two-piece sensor with separate electronic box incl. progr. keys and display for measurement: MT: through flames F2: CO ₂ flame gas F6: CO flame gas	Two-piece sensor with separate electronic box for measurement of glass, incl. programming keys and display	Two-piece sensor with separate electronic box for measurement of ultra-thin glass sheets, incl. programming keys and display	Two-piece sensor with separate electronic box for measurement of ultra-thin plastic foils, incl. programming keys and display	Ratio pyrometer with separate electronic box for high temp. measurement of metal with green laser, incl. programming keys and display	
Detector	Thermopile	Si	1M: Si / 2M: InGaAs	Extended InGaAs	InAsSb	Thermopile	Thermopile	Thermopile	Thermopile	Sandwich	
Sensing head exchangeable	■	■	■	■	–	■	■	■	■	–	
Head cable shortening	■ [max. 6 m]	■ [max. 6 m]	■ [max. 6 m]	■ [max. 6 m]	■	■ [max. 6 m]	■ [max. 6 m]	■ [max. 6 m]	■ [max. 6 m]	–	
Thread (sensing head)	M48x1.5	M48x1.5	M48x1.5	M48x1.5	M48x1.5	M48x1.5	M48x1.5	M48x1.5	M48x1.5	M18x1	
Spectral range	8–14 µm	0.525 µm	1M: 1.0 µm 2M: 1.6 µm	2.3 µm	2.2–6 µm	MT: 3.9 µm / F2: 4.24 µm / F6: 4.64 µm	5.0 µm	7.9 µm	7.9 µm	1M: 0.8–1.1 µm 2M: 1.45–1.75 µm	
Temperature ranges	–50 ... 975 °C	1000 ... 2000 °C	1ML: 485 ... 1050 °C 1MH: 650 ... 1800 °C 1MH1: 800 ... 2200 °C 2ML: 250 ... 800 °C 2MH: 385 ... 1600 °C 2MH1: 490 ... 2000 °C	L: 50 ... 400 °C H: 100 ... 600 °C H1: 150 ... 1000 °C H2: 200 ... 1500 °C H3: 250 ... 1800 °C	0 °C ... 500 °C	MT / F2 / F6: 200 ... 1450 °C MTH / F2H / F6H: 400 ... 1650 °C	L: 100 ... 1200 °C H: 250 ... 1650 °C HF: 200 ... 1450 °C H1F: 400 ... 1650 °C	100 ... 1200 °C	0 ... 710 °C	1ML: 525 ... 1400 °C 1MH: 700 ... 2000 °C 1MH1: 1000 ... 3000 °C 2ML: 275 ... 1000 °C 2MH: 400 ... 1500 °C 2MH1: 550 ... 3000 °C	
Temperature resolution	LT: 0.1 K / LTF: 0.5 K	0.2 K	0.1 K	0.1 K	0.1 K	0.1 K	0.1 K	0.5 K	0.5 K	0.1 K (>900 °C)	
Optical resolution	LT: 75:1 LTF: 50:1	150:1	L: 150:1 H: 300:1	L: 60:1 / H: 100:1 / H1-H3: 300:1	30:1	45:1	L / HF / H1F: 45:1 H: 70:1	45:1	45:1	1ML / 2ML: 38:1 / 2MH: 50:1 / 1MH / 1MH1 / 2MH1: 100:1	
Option: CF lens	–	–	–	–	■	–	–	–	–	■	
Smallest spot (CF optics/ add. CF lens)	LT: 0.9 mm @ 70 mm LTF: 1.4 mm @ 70 mm	–	0.5 mm @ 150 mm	0.5 mm @ 150 mm	2.4 mm @ 70 mm	1.6 mm @ 70 mm	1 mm @ 70 mm	1.6 mm @ 70 mm	1.6 mm @ 70 mm	1.5 mm @ 150 mm	
Smallest spot (SF optics)	LT: 16 mm @ 1200 mm LTF: 24 mm @ 1200 mm	7.3 mm @ 1100 mm	3.7 mm @ 1100 mm	11 mm @ 1100 mm	36.7 mm @ 1100 mm	27 mm @ 1200 mm	17 mm @ 1200 mm	27 mm @ 1200 mm	27 mm @ 1200 mm	3 mm @ 300 mm	
Sighting	Double laser	Double laser	Double laser	Double laser	Double laser	Double laser	Double laser	Double laser	Double laser	Laser	
Response time (90 %)	LT: 120 ms / LTF: 9 ms	1 ms	1 ms	1 ms	300 µs (90 µs exposure time)	10 ms	L: 120 ms / H: 80 ms HF / H1F: 10 ms	150 ms	150 ms	1 ms – 10 s	
Accuracy	LT: ±1 °C or ±1 % LTF: ±1.5 °C or ±1.5 %	±(0.3 % T _{Meas} + 2 °C)	±(0.3 % T _{Meas} + 2 °C)	±(0.3 % T _{Meas} + 2 °C)	±(0.3 % T _{Meas} + 2 °C)	±1 %	±1.5 °C or ±1 %	±1.5 °C or ±1 %	±1.5 °C or ±1 %	±(0.5 % T _{Meas} + 2 °C)	
Outputs analog: 0–20 mA / 4–20 mA / 0–5 V / 0–10 V / t/c (K/J)	■ / ■ / ■ / ■ / ■	■ / ■ / ■ / ■ / ■	■ / ■ / ■ / ■ / ■	■ / ■ / ■ / ■ / ■	■ / ■ / ■ / ■ / ■	■ / ■ / ■ / ■ / ■	■ / ■ / ■ / ■ / ■	■ / ■ / ■ / ■ / ■	■ / ■ / ■ / ■ / ■	■ / ■ / – / – / –	
Second analog output	■	–	–	–	■	■	■	■	■	■	
Interfaces: USB / RS232 / RS485 / Profibus / Ethernet / Modbus RTU / Relay	■ / ■ / ■ / ■ / ■ / ■	■ / ■ / ■ / ■ / ■ / ■	■ / ■ / ■ / ■ / ■ / ■	■ / ■ / ■ / ■ / ■ / ■	■ / ■ / ■ / – / ■ / ■ / ■	■ / ■ / ■ / ■ / ■ / ■	■ / ■ / ■ / ■ / ■ / ■	■ / ■ / ■ / ■ / ■ / ■	■ / ■ / ■ / ■ / ■ / ■	■ / ■ / ■ / ■ / ■ / ■	■ / ■ / ■ / – / ■ / ■ / ■
Signal processing: Peak / Valley / AVG / Advanced hold	■ / ■ / ■ / ■	■ / ■ / ■ / ■	■ / ■ / ■ / ■	■ / ■ / ■ / ■	■ / ■ / ■ / ■	■ / ■ / ■ / ■	■ / ■ / ■ / ■	■ / ■ / ■ / ■	■ / ■ / ■ / ■	■ / ■ / ■ / ■	
T_{Amb} Head min.	–20 °C	–20 °C	–20 °C	–20 °C	0 °C	–20 °C	–20 °C	–20 °C	–20 °C	–20 °C	
T_{Amb} Head max.	85 °C	85 °C	85 °C	85 °C	70 °C	85 °C	85 °C	85 °C	85 °C	200 °C (optional: 315 °C)	
T_{Amb} Electronics max.	85 °C	85 °C	85 °C	85 °C	70 °C	85 °C	85 °C	85 °C	85 °C	1M: 60 °C / 2M: 50 °C	
Functional inputs/ number	■ / 3	■ / 3	■ / 3	■ / 3	– / –	■ / 3	■ / 3	■ / 3	■ / 3	– / –	
External emissivity adjustment	■	■	■	■	■	■	■	■	■	■	
External background temperature control	■	■	■	■	■	■	■	■	■	■	
Trigger input for reset of hold functions	■	■	■	■	■	■	■	■	■	■ (via I/O-Pins)	
Digital I/O pins/ number	–	–	–	–	■ (via I/O pins)	–	–	–	–	■ / 3	
Simultaneous analog and digital output	■	■	■	■	■	■	■	■	■	■	
Alarm output as alternative to analog output	■	■	■	■	■	■	■	■	■	■	
Additional alarm output/ switching output	■	■	■	■	■ (via I/O pins)	■	■	■	■	■ (via I/O-Pins)	
Voltage supply	8–36 V DC	8–36 V DC	8–36 V DC	8–36 V DC	8–30 V DC / 5 V USB / max. 1.2 W	8–36 V DC	8–36 V DC	8–36 V DC	8–36 V DC	8–30 V DC or USB	
Standard cable length	3 m	3 m	3 m	3 m	3 m	3 m	3 m	3 m	3 m	3 m	
Cable length options	8 / 15 m	8 / 15 m	8 / 15 m	8 / 15 m	8 / 15 m	8 / 15 m	8 / 15 m	8 / 15 m	8 / 15 m	8 / 15 m	



Basic model	CSvideo	CSvideo	CTvideo	CTvideo
Type	2M (L / H)	3M (L / H)	1M / 2M (L / H)	3M (L / H)
Classification / special features	Single-piece two wire sensor with electronics in sensing head, video camera and cross hair laser for measuring metal	Single-piece two wire sensor for low temperature measurement of metals with electronics in sensing head, video camera and cross hair laser	Two-piece sensor with electronic box for high temperature measurement of metals, video camera and cross hair laser	Two-piece sensor with electronic box for low temperature measurement of metals, video camera and cross hair laser
Detector	InGaAs	InGaAs	1M: Si / 2M: InGaAs	Extended InGaAs
Sensing head exchangeable	-	-	[+CT 1M / 2M]	[+CT 3M]
Head cable shortening	■	■	[max. 6 m]	[max. 6 m]
Thread (sensing head)	M48x1.5	M48x1.5	M48x1.5	M48x1.5
Spectral range	1.6 µm	2.3 µm	1M: 1.0 µm / 2M: 1.6 µm	2.3 µm
Temperature ranges (scalable via software)	2ML: 250 ... 800 °C 2MH: 385 ... 1600 °C	3ML: 50 ... 400 °C 3MH: 100 ... 600 °C	1ML: 485 ... 1050 °C 1MH: 650 ... 1800 °C 1MH1: 800 ... 2200 °C 2ML: 250 ... 800 °C 2MH: 385 ... 1600 °C 2MH1: 490 ... 2000 °C	3ML: 50 ... 400 °C 3MH: 100 ... 600 °C 3MH1 ¹⁾ : 150 ... 1000 °C 3MH2 ¹⁾ : 200 ... 1500 °C 3MH3 ¹⁾ : 250 ... 1800 °C
Temperature resolution	0.1 K	0.1 K	ML: 0.1 K / MH: 0.1 K	0.1 K
Optical resolution	2MH: 300:1 / 2ML: 150:1	3ML: 60:1 / 3MH: 100:1	L: 150:1 / H: 300:1	L: 60:1 / H: 100:1 / H1-H3: 300:1
Smallest spot (CF optics) CF vario optics: focusable from 90 mm to 250 mm	2ML: 0.6 mm @ 90 mm 2MH: 0.3 mm @ 90 mm	3ML: 1.5 mm @ 90 mm 3MH: 0.9 mm @ 90 mm	1ML / 2ML: 0.6 mm @ 90 mm 1MH-H1 / 2MH-H1: 0.3 mm @ 90 mm	3ML: 1.5 mm @ 90 mm 3MH: 0.9 mm @ 90 mm 3MH1-H3: 0.3 mm @ 90 mm
Smallest spot (SF optics) SF vario optics: focusable from 200 mm to infinity	2ML: 1.3 mm @ 200 mm 2MH: 0.7 mm @ 200 mm	3ML: 3.3 mm @ 200 mm 3MH: 2.0 mm @ 200 mm	1ML / 2ML: 1.3 mm @ 200 mm 1MH-H1 / 2MH-H1: 0.7 mm @ 200 mm	3ML: 3.3 mm @ 200 mm 3MH: 2.0 mm @ 200 mm 3MH1-H3: 0.7 mm @ 200 mm
Sighting	video camera and cross hair laser	video camera and cross hair laser	video camera and cross hair laser	video camera and cross hair laser
Response time (90 %)	10 ms	20 ms	1 ms	1 ms
Accuracy	±(0.3% T _{Meas} + 2 °C)	±(0.3% T _{Meas} + 2 °C)	±(0.3% T _{Meas} + 2 °C)	±(0.3% T _{Meas} + 2 °C)
Outputs analog: 0-20 mA / 4-20 mA / 0-5 V / 0-10 V / t/c (K/J)	- / ■ / - / - / -	- / ■ / - / - / -	■ / ■ / ■ / ■ / ■	■ / ■ / ■ / ■ / ■
Interfaces: USB / RS232 / RS485 / Profibus / Ethernet	■ / - / - / - / ■	■ / - / - / - / ■	■ / - / - / - / ■	■ / - / - / - / ■
Signal processing: Peak / Valley / AVG / Advanced hold	■ / ■ / ■ / ■	■ / ■ / ■ / ■	■ / ■ / ■ / ■	■ / ■ / ■ / ■
T _{Amb} Head min.	-20 °C	-20 °C	-20 °C	-20 °C
T _{Amb} Head max.	70 °C	70 °C (50 °C at Laser ON)	70 °C	70 °C
T _{Amb} Electronics max.	70 °C	70 °C	85 °C	85 °C
Functional inputs / number	- / -	- / -	■ / 3	■ / 3
External emissivity adjustment	-	-	■	■
External background temperature control	-	-	■	■
Trigger input for reset of hold functions	-	-	■	■
Simultaneous analog and digital output	■	■	■	■
Alarm output as an alternative to analog output	■	■	■	■
Additional alarm output	0-30 V / 500 mA (open-collector)	0-30 V / 500 mA (open-collector)	24 V / 50 mA (open-collector)	24 V / 50 mA (open-collector)
Voltage supply	5-28 V DC	5-28 V DC	8-36 V DC	8-36 V DC
Standard cable length	3 m	3 m	3 m	3 m
Cable length options	8 / 15 m	8 / 15 m	5 / 10 m	5 / 10 m

1) Specifications available for object temperatures ≥ lower measurement range 50 °C

Software CompactConnect / CompactPlus Connect

Suitable for all optris infrared thermometer of the high performance series and compact line

- Automatic snapshots (time or temperature dependent) to control and document the process
- Graphic display and recording of the measurement values
- Setup of sensor parameters and signal processing functions
- Remote control of the sensor

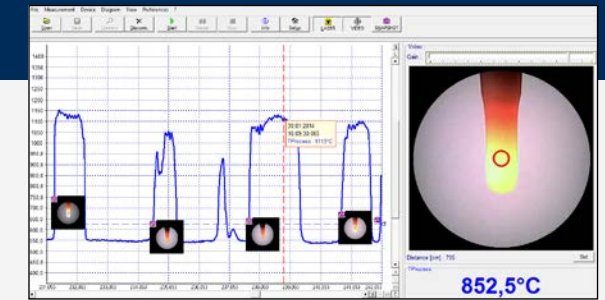

Connection options for CSvideo 2M

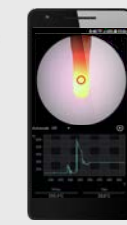
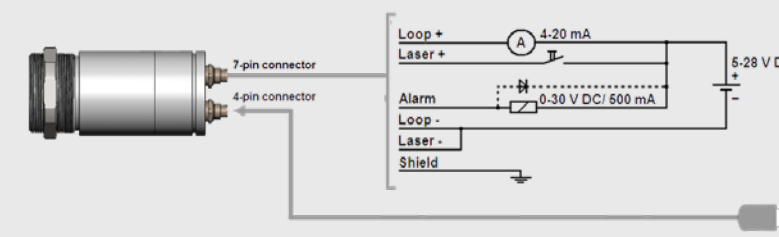

Analog operation mode:
4 – 20 mA and alarm interface
Setup & installation by IRmobile App via USB cable (Plug & Play)

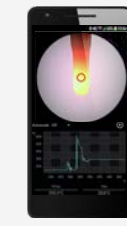

Digital operation mode:
process control (video and temperature) via IRmobile App

IRmobile App
tool for all optris pyrometers



- Change of the temperature unit: Celsius or Fahrenheit
- Integrated simulator
- Save / load configurations and T/ t diagrams

Pyrometer

- Alignment of the sensor via live video image with integrated simultaneous temperature display (CSvideo / CTvideo)
- Adjustment of emissivity, transmissivity and other parameters
- Scaling the analog output and setting the alarm output

Supported for

- PI and Xi series and all pyrometers
- For Android devices from version 5.0 or higher with Micro-USB or USB-C connectors that support USB OTG (On The Go)



Accessories CSlaser/ CTlaser/ CSvideo/ CTvideo series



Mechanical accessories			
ACCTLFB	ACCTLAB	ACHAMA	ACCTRAIL
Mounting bracket, adjustable in one axis	Mounting bracket, adjustable in two axes	Mounting adapter: Mounting and pipe flange incl. screws	Rail mount adapter for CT electronics
			

Optical accessories		Combinations		
ACHAST300 + ACHAPA	ACCJAFPCTL + ACCJAPWCTLSW	ACHAMA	ACHAST300 + ACHAPA	ACCTLRM
Sighting tube M48x1.5, 300 mm length + pipe adapter with M48x1.5 internal thread for CoolingJacket	Front part + Focussing unit with protective window for CoolingJacket	Mounting adapter	Sighting tube + pipe adapter	Furnace wall mount for CSlaser / CTlaser
				

Air purges and cooling units					
ACCTAPMH		ACCTLAP		ACCTLW	
Air purge collar CTratio		Air purge collar CxL / CxV		Water cooled housing CxL / CxV, stainless steel, for T _{Amb} up to 175 °C	
					
ACCTLCJA	ACCJAAPLS	ACCTLAP	ACCTLW		
CoolingJacket Advanced	Air purge laminar for CoolingJacket Advanced	Air purge collar	Water cooled housing	Cooling sensing head + purging of optics	
					

Applications

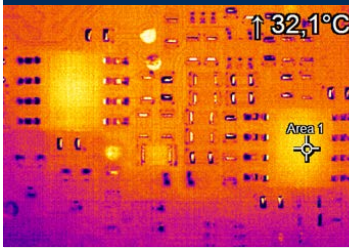
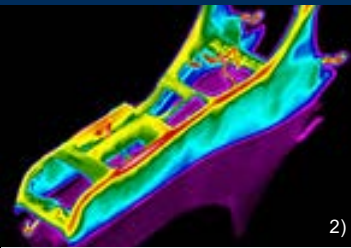
Applications pyrometer			
			
Laminating interior fittings of vehicles	Blown film extrusion	Sterilization of glass bottles	Inductive heat treatment of metals
Vehicle interiors are partly equipped with different surface decors during a laminating process. This process takes place at around 120°C – the decor temperature is controlled and optimized during this time.	From the moment the melt emerges through the die at the extruder, the temperature of the tubular film must be measured at different points in order to ensure product quality.	A sterilization of a defined temperature level is important to produce aseptic glass bottles for pharmaceutical products. The right temperature is secured and monitored by a punctual measuring pyrometer.	A variant of the heat treatment of metals is induction hardening. The desired microstructure of the metal depends on an optimal temperature-time curve.
Recommended device: CSmicro LT	Recommended device: CT P3	Recommended devices: CT G5, CT LT	Recommended device: CTlaser 1M

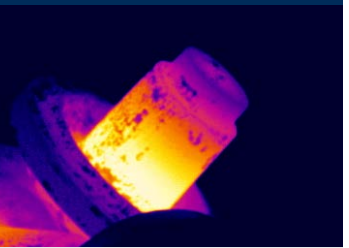
Applications infrared cameras			
			
Component inspection of circuit boards	Injection molding	Infrared technology in waste processing	Workpiece control during drop forging
More and more manufacturers of electronic circuit boards rely on noncontact temperature measurement due to the constantly increasing performance of their components.	In order to prevent component distortion during injection molding, the process is monitored by thermal imaging cameras detecting and adjusting temperature over- or undershoots during molded part measurement.	Early fire detection with infrared cameras is an important protective measure in industry to prevent irreparable damage to industrial plants and buildings.	In drop forging, the semi-finished products must be at a certain forging temperature before forming. In order to achieve the optimum production result, the surface temperature of the material is controlled accordingly.
Recommended devices: PI 640i Microscope optics, Xi 400 Microscope optics	Recommended device: PI 450i	Recommended device: Xi 400	Recommended devices: PI 1M, PI 05M

References: 1) AdobeStock / romaset 2) GTT Willi Steinko



Basic model	Xi 80	Xi 400	Xi 410
Type	IR	IR	IR
Detector	FPA, uncooled (34 µm pitch)	FPA, uncooled (17 µm pitch)	FPA, uncooled (17 µm pitch)
Optical resolution	80 x 80 pixels	382 x 288 pixels	384 x 240 pixels
Spectral range	8–14 µm	8–14 µm	8–14 µm
Temperature ranges	-20 ... 100 °C; 0 ... 250 °C; (20) 150 ... 900 °C ¹⁾	-20 ... 100 °C; 0 ... 250 °C; (20) 150 ... 900 °C; 200...1500 °C (Option)	-20 ... 100 °C; 0 ... 250 °C; (20) 150 ... 900 °C ¹⁾
Frame rate	50 Hz	80 Hz / 27 Hz	Ethernet: 25 Hz / USB: 4 Hz autonomous operation: (without PC) 1.5 Hz
Optics (FOV)	30° (f = 5.1 mm) 12° (f = 12.7 mm) 55° (f = 3.1 mm) 80° (f = 2.3 mm)	29° x 22° (f = 12.7 mm) 18° x 14° (f = 20 mm) 53° x 38° (f = 7.7 mm) 80° x 54° (f = 5.7 mm)	18° x 12° (f = 20 mm) 29° x 18° (f = 12.7 mm) 53° x 31° (f = 7.7 mm) 80° x 44° (f = 5.7 mm)
New: Microscope optics	–	18° x 14° (f = 20 mm), Smallest measuring spot (IFOV): 80 µm	–
Focus	Manual motor focus	Manual motor focus	Manual motor focus
Optical resolution (D:S)	190:1 (12° optics)	390:1 (18° optics)	390:1 (18° optics)
Thermal sensitivity (NETD)	100 mK	80 mK	80 mK
System accuracy (at T _{Amb} = 23 ± 5 °C)	±2 °C or ±2 %, whichever is greater	±2 °C or ±2 %, whichever is greater	±2 °C or ±2 %, whichever is greater
PC interfaces	USB 2.0 / Ethernet (100 Mbit/s) / PoE	USB 2.0 / optional USB to GigE (PoE) interface	USB 2.0 / Ethernet (100 Mbit/s) / PoE
Direct in-/outputs / Standard process interface (PIF)	1x 0/4–20 mA output 1x input (analog or digital) electrically isolated	1x 0–10 V input 1x digital input (max. 24 V) 1x 0–10 V output	1x 0/4–20 mA output 1x input (analog or digital) electrically isolated
Industrial process interface (PIF)	3x analog outputs (0/4–20 mA or 0–10 V) or alarm OUT (relais) 3x inputs (analog or digital), fail-safe (LED and relay), stackable up to 3 PIFs; electrically isolated	2 x 0–10 V inputs, 1 x digital input (max. 24 V), 3x 0/4-20 mA outputs, 3 x relais (0–30 V / 400 mA), faile-safe relay	3x analog outputs (0/4–20 mA or 0–10 V) and 3x alarm outputs (relais) / 3x inputs (analog or digital) / fail-safe (LED and relay) stackable up to 3 PIFs; electrically isolated
Cable length (USB)	USB: 1 m, 3 m, 5 m Ethernet: 100 m, RS485: 500 m	USB: 1 m, 3 m, 5 m, 10 m, 20 m	USB: 1 m, 3 m, 5 m Ethernet: 100 m, RS485: 500 m
Ambient temperature (T _{Amb})	0 °C ... 50 °C	0 °C ... 50 °C	0 °C ... 50 °C
Size / class	Ø 36 x 90 mm (M30x1 thread) / IP 67 (NEMA 4)	Ø 36 x 100 mm (M30x1 thread) / IP 67 (NEMA 4)	Ø 36 mm x 100 mm (M30x1 thread) / IP 67 (NEMA 4)
Weight (without mounting bracket)	201 - 210 g (depending on lens)	216 - 220 g (depending on lens)	216 - 220 g (depending on lens)
Shock / Vibration ²⁾	IEC 60068-2	IEC 60068-2	IEC 60068-2
Power supply	USB / PoE / 5-30 VDC	via USB	USB / PoE / 5-30 VDC
Scope of supply (standard)	<ul style="list-style-type: none"> Xi camera USB cable (1 m) Cable for in-/outputs (1 m) with terminal block Mounting bracket with tripod thread, mounting nut Software package optris PIX Connect Quick start guide 	<ul style="list-style-type: none"> Xi camera USB cable (1 m) Cable for in-/outputs (1 m) with terminal block Mounting bracket with tripod thread, mounting nut Software package optris PIX Connect Quick start guide 	<ul style="list-style-type: none"> Xi camera Ethernet / PoE cable (1 m) / USB cable (1 m) Cable for in-/outputs (1 m) with terminal block Mounting bracket with tripod thread, mounting nut Software package optris PIX Connect Quick start guide

Microscope optics for the inspection of assembled circuit boards



The new microscope optics for the optris Xi 400 infrared camera allows reliable temperature measurement on tiny objects from 240 µm (MFOV). In combination with a suitable stand, this enables professional measurement of printed circuit boards and components in the electronics industry. The measuring distance between camera and object is variable between 90 and 110 mm. Due to the built-in motor focus, the camera can be easily mounted in the supplied PIX Connect software focus. For measuring even smaller objects we recommend the PI 640i microscope optics, smallest measuring spot: 28 µm (IFOV).



Further information on page 21 and www.optris.global/optris-xi-400-microscope-optics

1) Accuracy effective starting at 150 °C

2) For further details see operator's manual

Air purge unit	Water cooled housing	Shutter
ACXIAPL + ACXIAPLAB (Mounting bracket)	ACXIW	ACXISCBxx* + ACXIAPLAB (Mounting bracket)
Features <ul style="list-style-type: none"> The air purge attachment can be used in combination with the water cooled housing and protects the optics from contamination Used in rough and dusty areas to guarantee a reliable temperature measurement 	Features <ul style="list-style-type: none"> The rugged water cooled housing allows the Xi infrared cameras to be employed in hot environments up to 250°C Respective heat-resistant cables are also available 	Features <ul style="list-style-type: none"> In addition Xi cameras can be equipped with a shutter The shutter protects the optics from falling parts within a response time of 100 ms
		

*) xx = for different cable lengths

Outdoor protective housing for Xi series	USB server Gigabit 2.0 for Xi 400	Industrial process interface (PIF) for Xi series
ACXIOPH24	ACPIUSBSGB	Xi 80 / Xi 410: ACXIPIFCBx* Xi 400: ACPIPIFACBx*
Features <ul style="list-style-type: none"> Environmental rating IP 66 Additional air purge collar allows continuous operation in dusty and humid environments Heating element and built-in fan enable for a 24/7 operation from -40 °C to 50 °C Installation of USB Server Gigabit 2.0 and industrial process interface possible for integration into control systems over large outdoor distances 	Features <ul style="list-style-type: none"> Fully USB 2.0 compatible, Data rates: 1.5 / 12 / 480 mbps, USB transfer mode: Isochronous Network connection via Gigabit Ethernet Full TCP/IP support incl. routing and DNS Two independent USB ports Supply from PoE or external power supply with 24 – 48 V DC Galvanic isolation 500 V_{RMS} (network connection) Remotely configurable via Web Based Management 	Features <ul style="list-style-type: none"> Industrial process interface for Xi 400 with 3 analog / alarm outputs, 2 analog inputs, 1 digital input, 3 alarm relais Industrial process interface for Xi 80 and Xi 410 with 3 analog- / alarm outputs, 3 inputs (analog or digital), 3 alarm relais 500 V AC_{RMS} isolation voltage between camera and process Separate fail-safe relay output Xi hardware including all cable connections and PIX Connect software are permanently observed during operation Option Xi 80: stackable up to 3 PIFs



*) x = for different cable lengths

Infrared cameras

with high resolution for fast online applications and exchangeable lenses, including line scan function

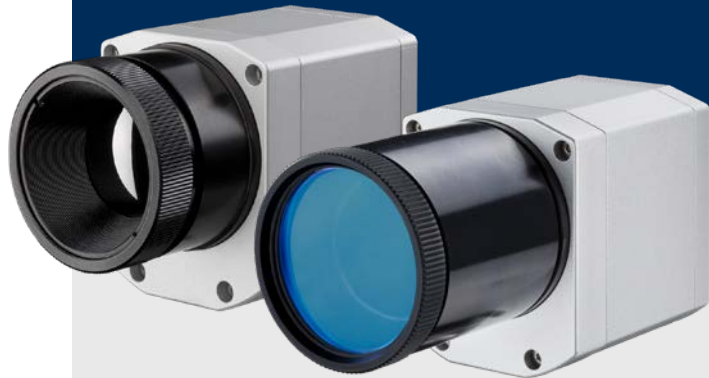

PI series Precision Line

The optris infrared cameras of the PI Precision Line offer imaging infrared temperature measurement devices for numerous industrial applications. From all-round talents like the optris PI 400i / 450i to high resolution VGA cameras (optris PI 640i) and special imagers for metal as well as glass applications and even microscope images, we meet your every expectation.



For further information on our infrared cameras see our



[Infrared camera brochure](#)

www.optris.global/downloads-infrared-cameras



Infrared cameras PI series						
Basic model		PI 400i / PI 450i	PI 640i	PI 640i Microscope optics	PI 450i G7	PI 640i G7
Type		IR	IR	IR	IR	IR
Detector		FPA, uncooled (17 µm pitch)	FPA, uncooled (17 µm pitch)	FPA, uncooled (17 µm pitch)	FPA, uncooled (17 µm pitch)	FPA, uncooled (17 µm pitch)
Optical resolution		382 x 288 pixels	640 x 480 pixels VGA	640 x 480 pixels @ 32 Hz 640 x 120 pixels @ 125 Hz	382 x 288 pixels	640 x 480 pixels
Spectral range		8 – 14 µm	8 – 14 µm	8 – 14 µm	7.9 µm	7.9 µm
Temperature ranges		-20 ... 100 °C 0 ... 250 °C (20) 150 ... 900 °C ¹⁾ 200 ... 1500 °C (Option)	-20 ... 100 °C 0 ... 250 °C (20) 150 ... 900 °C ¹⁾ 200 ... 1500 °C (Option)	-20 ... 100 °C 0 ... 250 °C (20) 150 ... 900 °C ¹⁾ 200 ... 1500 °C (Option)	150 ... 900 °C 200 ... 1500 °C	150 ... 900 °C 200 ... 1500 °C
Frame rate		80 Hz / switchable to 27 Hz	32 Hz / 125 Hz in subframe mode (640 x 120 pixels)	32 Hz / 125 Hz in subframe mode (640 x 120 pixels)	80 Hz / switchable to 27 Hz	32 Hz / 125 Hz in subframe mode (640 x 120 pixels)
Optics (FOV)		29° x 22° / f = 12.7 mm or 18° x 14° / f = 20 mm or 53° x 38° / f = 7.7 mm or 80° x 54° / f = 5.7 mm	33° x 25° / f = 18.7 mm or 15° x 11° / f = 41.5 mm or 60° x 45° / f = 10.5 mm or 90° x 64° / f = 7.7 mm	12° x 9° (F=1.1) / f = 44 mm Smallest measuring spot (IFOV): 28 µm	29° x 22° / f = 12.7 mm or 18° x 14° / f = 20 mm or 53° x 38° / f = 7.7 mm or 80° x 54° / f = 5.7 mm	33° x 25° / f = 18.7 mm or 15° x 11° / f = 42 mm or 60° x 45° / f = 10.5 mm or 90° x 64° / f = 7.7 mm
Thermal sensitivity (NETD)		PI 400i: 75 mK with 29°, 53°, 80° FOV PI 450i: 40 mK with 29°, 53°, 80° FOV optics mentioned above: F = 0.9 PI 400i: 0.1 K with 18° FOV / F = 1.1 PI 450i: 60 mK with 18° FOV / F = 1.1	40 mK with 33°, 60° und 90° FOV 60 mK with 15° FOV	80 mK	150 mK 175 mK (with 18° FOV)	80 mK with 33°, 60°, 90° FOV 120 mK with 15° FOV
System accuracy (at T _{Amb} = 23 ± 5 °C)		±2 °C or ±2 %, whichever is greater	±2 °C or ±2 %, whichever is greater	±2 °C or ±2 %, whichever is greater	±2 °C or ±2 %, whichever is greater	±2 °C or ±2 %, whichever is greater
Temperature coefficient		±0.05 % / K ²⁾	±0.05 % / K ²⁾	±0.05 % / K ²⁾	-	-
PC interfaces		USB 2.0 / optional USB to GigE (PoE) Interface	USB 2.0 / optional USB to GigE (PoE) Interface	USB 2.0 / optional USB to GigE (PoE) Interface	USB 2.0 / optional USB to GigE (PoE) Interface	USB 2.0 / optional USB to GigE (PoE) Interface
Process interface (PIF)	Standard PIF	1x 0 – 10 V input, 1x digital input (max. 24 V), 1x 0 – 10 V output	1x 0 – 10 V input, 1x digital input (max. 24 V), 1x 0 – 10 V output	1x 0 – 10 V input, 1x digital input (max. 24 V), 1x 0 – 10 V output	1x 0 – 10 V input, 1x digital input (max. 24 V), 1x 0 – 10 V output	1x 0 – 10 V input, 1x digital input (max. 24 V), 1x 0 – 10 V output
	Industrial PIF (optional)	2x 0 – 10 V input, 1x digital input (max. 24 V), 3x 0 / 4– 20 mA output, 3x relais (0 – 30 V / 400 mA), 1x fail-safe-relay	2x 0 – 10 V input, 1x digital input (max. 24 V), 3x 0 / 4– 20 mA output, 3x relais (0 – 30 V / 400 mA), 1x fail-safe-relay	2x 0 – 10 V input, 1x digital input (max. 24 V), 3x 0 / 4– 20 mA output, 3x relais (0 – 30 V / 400 mA), 1x fail-safe-relay	2x 0 – 10 V input, 1x digital input (max. 24 V), 3x 0 / 4– 20 mA output, 3x relais (0 – 30 V / 400 mA), 1x fail-safe-relay	2x 0 – 10 V input, 1x digital input (max. 24 V), 3x 0 / 4– 20 mA output, 3x relais (0 – 30 V / 400 mA), 1x fail-safe-relay
Ambient temperature (T _{Amb})		PI 400i: 0 ... 50 °C / PI 450i: 0 ... 70 °C	0 ... 50 °C	0 ... 50 °C	0 ... 70 °C	0 ... 50 °C
Storage temperature		PI 400i: -40... 70 °C / PI 450i: -40 ... 85 °C	-40 ... 85 °C	-40 ... 70 °C	-40 ... 85 °C	-40 ... 85 °C
Relative Humidity		10 – 95 %, non-condensing	10 – 95 %, non-condensing	10 – 95 %, non-condensing	10 – 95 %, non-condensing	10 – 95 %, non-condensing
Size / class		46 x 56 x 68 – 77 mm (depending on lens and focus position) / IP 67 (NEMA 4)	46 x 56 x 76 - 100 mm (depending on lens and focus position) / IP 67 (NEMA 4)	46 x 56 x 119 - 126 mm (depending on lens and focus position) / IP 67 (NEMA 4)	46 x 56 x 68 – 77 mm (depending on lens and focus position) / IP 67 (NEMA 4)	46 x 56 x 76 – 100 mm (depending on lens and focus position) / IP 67 (NEMA 4)
Weight		237 - 251 g, depending on lens	269 - 340 g, depending on lens	370 g, depending on lens	237 - 251 g, depending on lens	269 - 340 g, depending on lens
Shock / Vibration ³⁾		IEC 60068-2	IEC 60068-2	IEC 60068-2	IEC 60068-2	IEC 60068-2
Tripod mount		1/4 - 20 UNC	1/4 - 20 UNC	1/4 - 20 UNC	1/4 - 20 UNC	1/4 - 20 UNC
Power supply		via USB	via USB	via USB	via USB	via USB
Scope of supply (standard)		<ul style="list-style-type: none"> • USB camera with 1 lens • USB cable (1 m) • Table tripod • PIF cable with terminal block (1 m) • Manual • Aluminum case (PI 400i) • Rugged outdoor case (PI 450i) • Software package optris PIX Connect 	<ul style="list-style-type: none"> • USB camera with 1 lens • USB cable (1 m) • Table tripod • PIF cable with terminal block (1 m) • Manual • Rugged outdoor case • Software package optris PIX Connect 	<ul style="list-style-type: none"> • USB camera with lens kit (standard lens [PI 640i: O33], microscope lens [MO44]) • Microscope stand • Standard USB cable (1 m) • Standard-PIF • Manual • Rugged outdoor case • Software package optris PIX Connect 	<ul style="list-style-type: none"> • USB camera with 1 lens • USB cable (1 m) • Table tripod • PIF cable with terminal block (1 m) • Manual • Rugged outdoor case • Software package optris PIX Connect 	<ul style="list-style-type: none"> • USB camera with 1 lens • USB cable (1 m) • Table tripod • PIF cable with terminal block (1 m) • Manual • Rugged outdoor case • Software package optris PIX Connect

1) Accuracy effective starting at 150 °C 2) For T_{Amb} 10...50 °C and T_{Obj} ≤ 500 °C; otherwise: ± 0.1 K/K or 0.1%/K (whichever is greater) 3) For further details see operator's manual

Basic model		PI 05M	PI 08M	PI 1M
Infrared cameras PI series				
Type		IR	IR	IR
Detector		CMOS (15 µm pitch)	CMOS (15 µm pitch)	CMOS (15 µm pitch)
Optical resolution		764 x 480 pixels @ 32Hz 382 x 288 pixels @ 80Hz (switchable to 27 Hz) 72 x 56 pixels @ 1kHz 764 x 8 pixels @ 1kHz (fast line scan mode)	764 x 480 pixels @ 32Hz 382 x 288 pixels @ 80Hz (switchable to 27 Hz) 72 x 56 pixels @ 1kHz 764 x 8 pixels @ 1kHz (fast line scan mode)	764 x 480 pixels @ 32Hz 382 x 288 pixels @ 80Hz (switchable to 27 Hz) 72 x 56 pixels @ 1kHz 764 x 8 pixels @ 1kHz (fast line scan mode)
Spectral range		500 – 540 nm	780 – 820 nm	0.85 – 1.1 µm
Temperature range		900 ... 2450 °C (27 Hz mode) 950 ... 2450 °C (32 / 80 Hz modes) 1100 ... 2450 °C (1 kHz mode)	575 ... 1900 °C (27 Hz mode) 625 ... 1900 °C (32 / 80 Hz mode) 750 ... 1900 °C (1 kHz mode)	450 ¹⁾ ... 1800 °C (27 Hz mode) 500 ¹⁾ ... 1800 °C (80 / 32 Hz mode) 600 ¹⁾ ... 1800 °C (1 kHz mode)
Frame rate		Up to 1 kHz / 1 ms real time analog output (0 - 10 V) of 8 x 8 pixels (freely selectable)	Up to 1 kHz / 1 ms real time analog output (0 - 10 V) of 8 x 8 pixels (freely selectable)	Up to 1 kHz / 1 ms real time analog output (0 - 10 V) of 8 x 8 pixels (freely selectable)
Optics (FOV)		FOV @ 764 x 480 px: 26° x 16° (f=25 mm) FOV @ 382 x 288 px: 13° x 10° (f=25 mm)	FOV @ 764 x 480 px: 26° x 16° (f=25 mm) FOV @ 382 x 288 px: 13° x 10° (f=25 mm) 39° x 25° (f=16 mm) 20° x 15° (f=16 mm)	FOV @ 764 x 480 px: 39° x 25° (f=16 mm) FOV @ 382 x 288 px: 20° x 15° (f=16 mm) 26° x 16° (f=25 mm) 13° x 10° (f=25 mm) 13° x 8° (f=50 mm) 7° x 5° (f=50 mm) 9° x 5° (f=75 mm) 4° x 3° (f=75 mm)
Thermal sensitivity NETD²⁾		< 2 K (< 1400 °C) < 4 K (< 2100 °C)	< 2 K (< 1000 °C) < 4 K (< 1600 °C)	< 2 K (< 900 °C) < 4 K (< 1400 °C)
System accuracy (at T_{Amb} = 23 ± 5 °C)		For object temperature < 2000 °C: ±1 % of reading for 27/32/80 Hz ±1.5 % of reading for 1 kHz For object temperature > 2000 °C: ±2 % of reading for 27/32/80 Hz ±2.5 % of reading for 1 kHz	For object temperature < 1500 °C: ±1 % of reading for 27/32/80 Hz ±1.5 % of reading for 1 kHz For object temperature > 1500 °C: ±2 % of reading for 27/32/80 Hz ±2.5 % of reading for 1 kHz	For object temperature < 1400 °C: ±1 % of reading for 27/32/80 Hz ±1.5 % of reading for 1 kHz For object temperature < 1600 °C: ±2 % of reading for 27/32/80 Hz ±2.5 % of reading for 1 kHz
PC interfaces		USB 2.0 / optional USB to GigE (PoE) interface	USB 2.0 / optional USB to GigE (PoE) interface	USB 2.0 / optional USB to GigE (PoE) interface
Process Interface (PIF)	Standard PIF	1x 0 – 10 V input, 1x digital input (max. 24 V), 1x 0 – 10 V output	1x 0 – 10 V input, 1x digital input (max. 24 V), 1x 0 – 10 V output	1x 0 – 10 V input, 1x digital input (max. 24 V), 1x 0 – 10 V output
	Industrial PIF (optional)	2x 0 – 10 V inputs, 1x digital input (max. 24 V), 3x 0 / 4-20 mA outputs, 3x relays (0 – 30 V / 400 mA), 1x fail-safe relay	2x 0 – 10 V inputs, 1x digital input (max. 24 V), 3x 0 / 4-20 mA outputs, 3x relays (0 – 30 V / 400 mA), 1x fail-safe relay	2x 0 – 10 V inputs, 1x digital input (max. 24 V), 3x 0 / 4-20 mA outputs, 3x relays (0 – 30 V / 400 mA), 1x fail-safe relay
Ambient temperature (T_{Amb})³⁾		5 ... 50 °C	5 ... 50 °C	5 ... 50 °C
Storage temperature		– 40 ... 70 °C	– 40 ... 70 °C	– 40 ... 70 °C
Relative Humidity		10–95 %, non-condensing	10–95 %, non-condensing	10–95 %, non-condensing
Size / class		46 x 56 x 88 – 129 mm with protection tube (depending on lens and focus position) / IP 67 (NEMA 4)	46 x 56 x 88 – 129 mm with protection tube (depending on lens and focus position) / IP 67 (NEMA 4)	46 x 56 x 88 – 129 mm with protection tube (depending on lens and focus position) / IP 67 (NEMA 4)
Weight		245 - 311 g, depending on lens	245 - 311 g, depending on lens	245 - 311 g, depending on lens
Shock / Vibration⁴⁾		IEC 60068-2	IEC 60068-2	IEC 60068-2
Tripod mount		1/4-20 UNC	1/4-20 UNC	1/4-20 UNC
Power supply		via USB	via USB	via USB
Scope of supply (standard)		<ul style="list-style-type: none"> • USB camera with 1 lens • Lens tube incl. protective window • USB cable (1 m) • Table tripod • PIF cable with terminal block (1 m) • Software package optris PIX Connect • Manual • Aluminum case • Optional: CoolingJacket, HT cable 	<ul style="list-style-type: none"> • USB camera with 1 lens • Lens tube incl. protective window • USB cable (1 m) • Table tripod • PIF cable with terminal block (1 m) • Software package optris PIX Connect • Manual • Aluminum case • Optional: CoolingJacket, HT cable 	<ul style="list-style-type: none"> • USB camera with 1 lens • Lens tube incl. protective window • USB cable (1 m) • Table tripod • PIF cable with terminal block (1 m) • Software package optris PIX Connect • Manual • Aluminum case • Optional: CoolingJacket, HT cable

1) Accuracy effective starting at +75 °C with optics (f = 50 mm and f = 75 mm) 2) Specified NETD value applies to all frequencies 3) For Ambient temperature at +25 °C
4) For further details see operator's manual

Glass inspection system for process control in glass tempering machines

New



With the new glass inspection system, temperature differences during glass hardening processes can be quickly detected, thus avoiding rejects and providing automatic quality monitoring.

The Top Down GIS 640 R system with temperature referencing by means of a sensor from below as well as automatic emissivity correction for standard and low-E glasses was specially developed for process control in glass tempering machines.

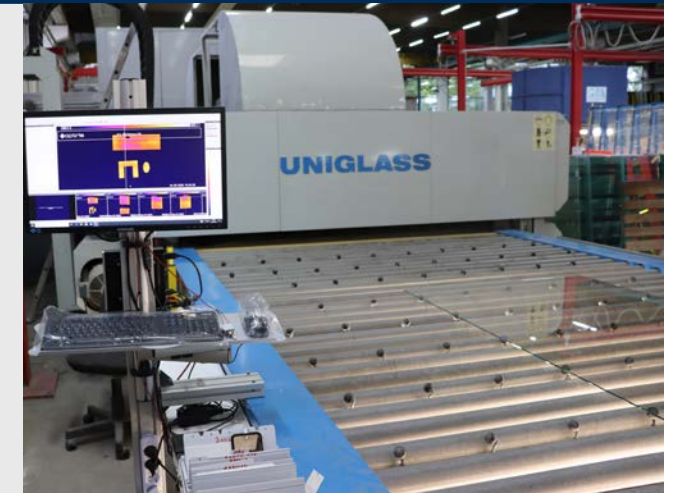

Measurement principle

A variety of optics with different field of views allows an optimal mounting of the camera at a larger distance (no cooling needed) and avoids influences by the angle dependent emissivity.

Positioning of IR camera and reference pyrometer in a Top Down Glass Inspection System.

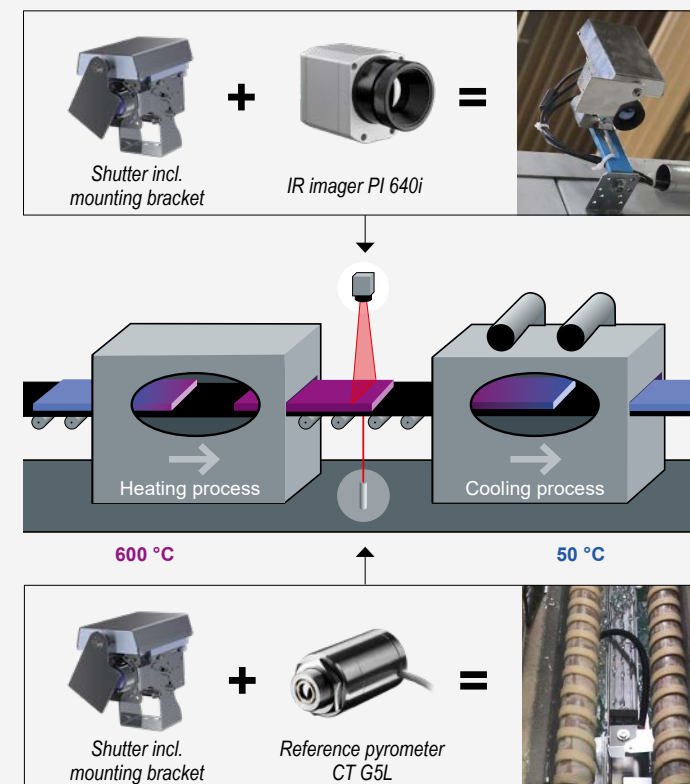

Software PIX Connect

Comprehensive IR camera software without licensing restrictions and with intuitive user interface.







Monitoring temperatures of glass sheets

Important specifications

- Top down system with additional reference pyrometer from underneath for automatic emissivity correction
- Digitally controlled lens protection system (DCLP) avoids extra air purging
- Glass area calculation
- Pre-assembled system for easy installation on glasstempering furnaces
- Automatic scan line adjustment – insensitive to distortions

Accessories PI series

Outdoor protective housing for infrared cameras	PI NetBox
part number: ACPIOPH	part number: OPTPINBW732G
<p>Features</p> <ul style="list-style-type: none"> • Environmental rating IP 66 • Additional air purge collar allows for a continuous operation in dusty and humid conditions • Heating element and built-in fan enable for a 24/7 operation from -40 °C to 50 °C • Installation of USB Server Gigabit 2.0 and industrial process interface possible for integration into control systems over large outdoor distances 	<p>Features</p> <ul style="list-style-type: none"> • Miniature PC as an add-on to the PI series for stand-alone system or for cable extension via GigE • Integrated hardware and software watchdog • Installation of additional user software possible • Status LEDs • Processor: Intel® E3845 Quad Core / 1.91 GHz, 16 GB SSD, 2 GB RAM • Connections: 2x USB 2.0, 1x USB 3.0, 1x Mini USB 2.0, Micro HDMI, Ethernet (Gigabit Ethernet), Micro SDHC / SDXC card • Wide supply voltage range (8 – 48 V DC) or Power over Ethernet (PoE) • Can be integrated into CoolingJacket Advanced
	

USB Server Gigabit 2.0 for optris PI cameras	Industrial Process Interface (PIF) for optris PI series
part number: ACPIUSBSGB	part number: ACPIPIFMA
<p>Features</p> <ul style="list-style-type: none"> • Fully USB 2.0 compatible, Data rates: 1.5 / 12 / 480 mbps, USB transfer mode: Isochronous • Network connection via Gigabit Ethernet • For optris PI series and Xi 400 as well as CTvideo / CSvideo series • Full TCP/IP support incl. routing and DNS • Two independent USB ports • Supply from PoE or external power supply with 24 – 48 V DC • Galvanic isolation 500 V_{RMS} (network connection) • Remotely configurable via Web Based Management 	<p>Features</p> <ul style="list-style-type: none"> • Industrial process interface for PI series with 3 analog / alarm outputs, 2 analog inputs, 1 digital input, 3 alarm relays • 500 V AC_{RMS} isolation voltage between camera and process • Separate fail-safe relay output • PI hardware including all cable connections and PIX Connect software are permanently observed during operation
	

Accessories PI series

Expansion options

CoolingJacket Advanced	Laminar air purge
part number: ACPICJA	part number: ACCJAAPLS
<p>Features</p> <ul style="list-style-type: none"> • Operation at ambient temperatures up to 315 °C • Air/ water cooling with integrated air purging and optional protective windows • Modular concept for easy installation of different devices and optics • Trouble-free sensor disassembling on site with quick release chassis • Integration of additional components like PI NetBox, USB Server Gigabit 2.0 and Industrial Process Interface (PIF) in extended version 	<p>Features</p> <ul style="list-style-type: none"> • Protection for rugged environments • Air and water cooling, flexible laminar air stream for protection from dirt and dust • Easy maintenance due to folding mechanism • Focussable from the outside once installed • Protection window for mechanical protection integrated • Also available as line scanner version
	

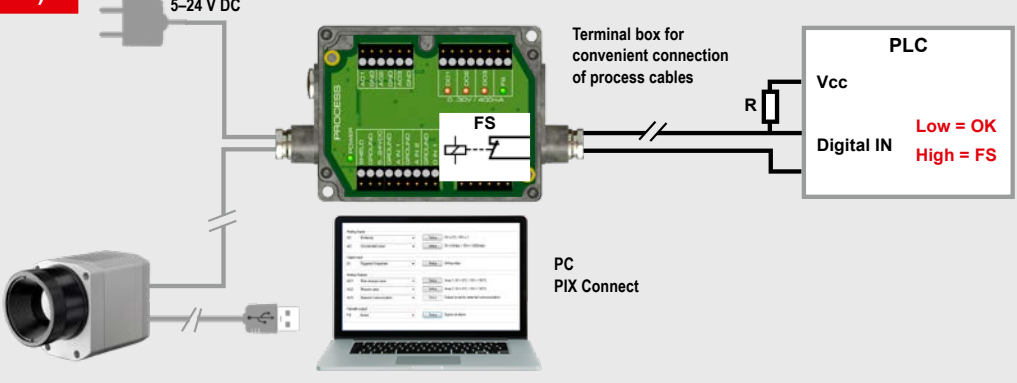
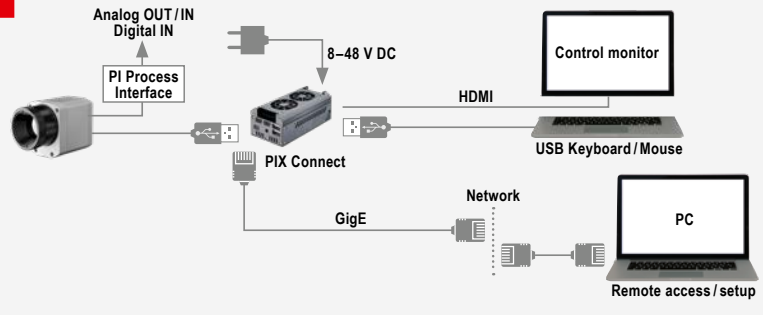
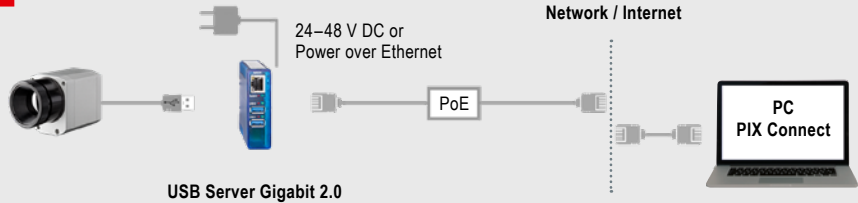
Connection options	
Industrial Process Interface (PIF)	
PI NetBox	
USB Server Gigabit 2.0	

PIX Connect Comprehensive IR camera software

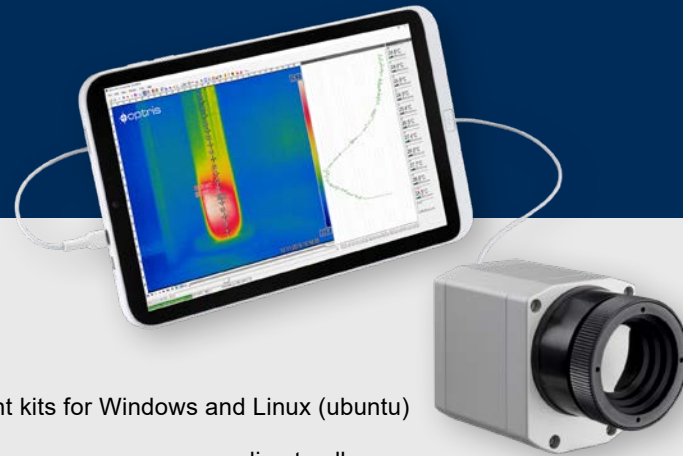

- No licensing restrictions
- Modern software with intuitive user interface
- Display of numerous images in different windows
- Extensive license-free analysis and two software development kits for Windows and Linux (ubuntu)

The **HummingBoard Edge computer** from SolidRun is a hardware we are recommending to all customers who want to integrate our PI and Xi imagers in their Linux based software by using our Direct SDK.

High degree of individualization for customer-specific imaging

- Various layout options for individual customization (window arrangement, toolbar)
- Temperature display in °C or °F
- Choice of individual measurement parameters tailored to the respective application

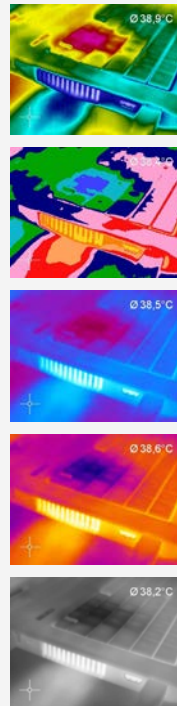

Detailed online and offline data analysis

- Detailed analysis with the help of measurement areas, automatic hot / cold spot search
- Logical linking of temperature information (measurement areas discrepancy, image subtraction)
- Slow-motion replay of radiometric datasets and analysis even without camera
- Editing of sequences, e.g. cut and save individual images
- Various color palettes to highlight thermal contrasts
- Adjustable signal processing (Max, Min, Average)

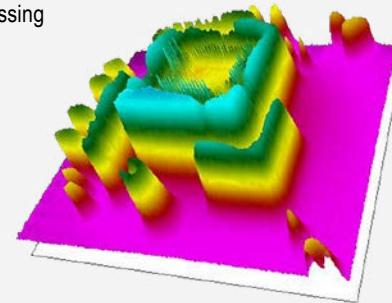

Automatic process control and quality control

- Individual setting of alarm thresholds depending on the process
- External communication of software via COM-ports, DLL
- Adjustment of thermal image via reference values
- Definition of visual or acoustic alarms and analog data output

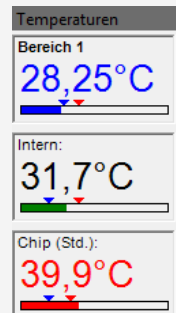

Video recording and snapshot function

- Manually or triggered data gathering
- Radiometric video sequences (*.ravi)
- Radiometric snapshots (*.tiff, *.csv for analysis in Excel)

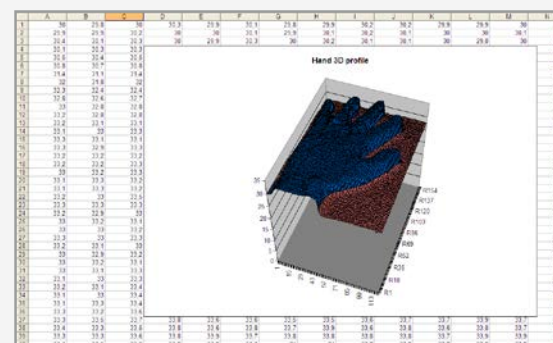

IRmobile The setting tool for all IR cameras



Infrared camera features

- Live IR image with automatic hot and cold spot search
- Adjustable camera features like temperature measuring range, frame rate and selectable color palettes
- Changing the temperature unit: Celsius or Fahrenheit
- Creating snapshots
- Integrated simulator

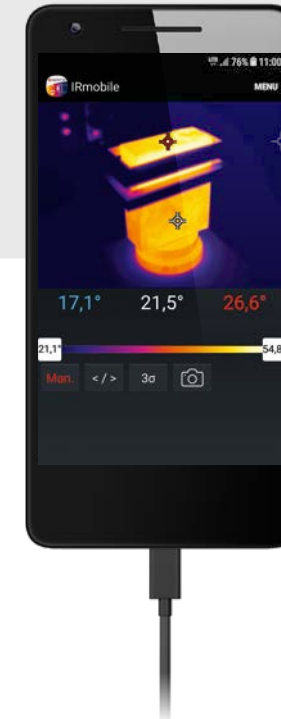

Supported for

- PI and Xi series and all pyrometers
- For android devices from version 5.0 or higher with micro-USB or USB-C connectors that support USB OTG

Optris calculator

Combines the measuring spot size calculator of the IR pyrometers and the optics calculator of the IR cameras

The measuring spot size of the respective device is calculated for each distance



Pyrometers

- The spot size calculator determines the exact spot size for all sensor / optics combinations for any entered distance
- For reliable measurements

IR cameras

- Based on camera / lens combination and the distance to the object, the measuring field dimensions and pixel size are calculated precisely.
- Ensures an optimal positioning of the camera and the avoidance of measuring errors

Features

- Calculates for each distance the measuring spot size of the respective device
- Always the current software and features through regular updates

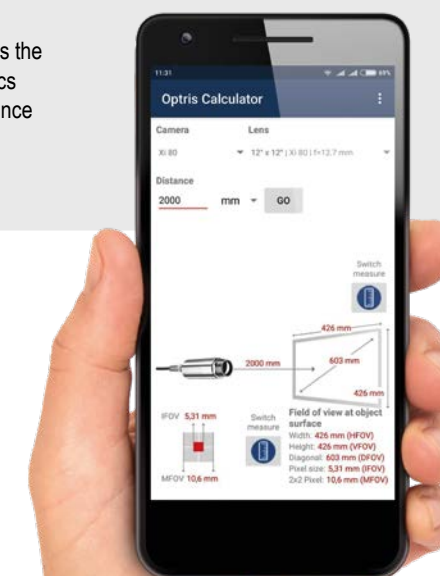

Supported for

- All android devices (5.0 or higher)





More about Optris:
www.optris.global

 [linkedin.com/company/optris](https://www.linkedin.com/company/optris)

 [youtube.com/c/OptrisEN](https://www.youtube.com/c/OptrisEN)

 twitter.com/optris

 [facebook.com/optris.gmbh](https://www.facebook.com/optris.gmbh)

when temperature matters

Optris GmbH
Ferdinand-Buisson-Str. 14
13127 Berlin · Germany

Phone: +49 30 500 197-0
Fax: +49 30 500 197-10
E-mail: info@optris.global
www.optris.global

