

CE DECLARATION OF CONFORMITY

As Manufacturer:

Monarch Instrument

Division of Monarch International Inc.
15 Columbia Drive, Amherst NH 03031 USA
declares under Monarch's sole responsibility that the product:

Pocket Laser Tach 200

to which this declaration relates is in conformity with the following directives and standards when installed and operated in accordance with the user manual:

Directives:	EMC 89/336/EEC
Standards:	EMC: EN61326:1997 Electrical Safety: IEC61010-1:2001 Laser Safety: IEC60825-1:2001

References: Retlif Testing Laboratories, (Report No. R-4283N)
Technical Construction File PLT-0704 of July 2004

24th June 2004

Manufacturer (Amherst,NH)

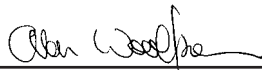

Alan Woolfson, VP Engineering (Authorized Signature)

Printed in the U.S.A.

Copyright 2006 Monarch Instrument, all rights reserved

1071-4838-114R

MONARCH INSTRUMENT

Instruction Manual



Pocket Laser Tach 200 (PLT200)

Tachometer / Rate Meter / Totalizer / Timer

15 Columbia Drive
Amherst, NH 03031-2334 USA
Phone: (603) 883-3390
Fax: (603) 886-3300
E-mail: support@monarchinstrument.com
Website: www.monarchinstrument.com

SAFEGUARDS AND PRECAUTIONS

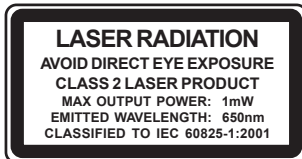

WARNING - This product emits a visible beam of laser light. Avoid exposure to the laser radiation. The use of optical viewing aids (binoculars, for example) may increase the ocular hazard.

CAUTION - The laser beam should not be intentionally aimed at people or animals.

CAUTION - Use of controls or adjustments or performance of procedures other than those specified herein may result in hazardous radiation exposure.



Read and follow all instructions in this manual carefully, and retain this manual for future reference.

Do not use this instrument in any manner inconsistent with these operating instructions or under any conditions that exceed the environmental specifications stated.

This instrument is not user serviceable. For technical assistance, contact the sales organization from which you purchased the product.



In order to comply with EU Directive 2002/96/EC on Waste Electrical and Electronic Equipment (WEEE): This product may contain material which could be hazardous to human health and the environment. DO NOT DISPOSE of this product as unsorted municipal waste. This product needs to be RECYCLED in accordance with local regulations, contact your local authorities for more information. This product may be returnable to your distributor for recycling - contact the distributor for details.

Monarch Instrument's Limited Warranty applies. See www.monarchinstrument.com for details.

Warranty Registration and Extended Warranty coverage available online at www.monarchinstrument.com.

14.0 OPTIONS /ACCESSORIES

T-5	Reflective Tape, 5 foot [1.5 m] roll, ½ inch [13 mm] wide
RCA	Remote Contact Assembly with 10 cm wheel, concave and convex tips
CTE	Concave/convex contact tips and 10 cm linear contact wheel
12 inch Wheel	12 inch circumference wheel for use with RCA
CA-4044-6	6 foot Input/Output cable, 1/8" mono phone plug to BNC connector
ROS-P	Remote Optical Sensor
ROS-P-25	Remote Optical Sensor with 25 foot cable
EC-25P	25 foot extension cable for all sensors
MT-190-P	Amplified Magnetic Sensor
IRS-P	Infrared Sensor
CC-10	Padded Nylon Carrying Case
CC-11	Latching Carrying Case for Pocket Tach and accessories
CAL-N.I.S.T.	N.I.S.T. Traceable Certificate of Calibration

12.0 BATTERIES

When displayed, replace batteries.



Remove battery cover

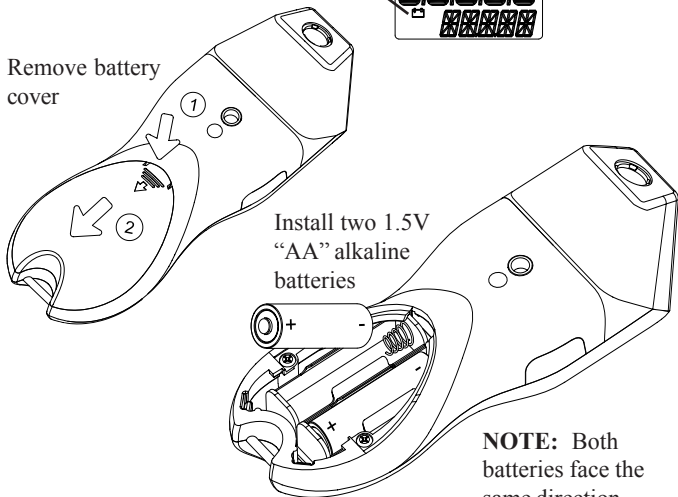

Install two 1.5V
"AA" alkaline
batteries

NOTE: Both
batteries face the
same direction.

13.0 CLEANING

To clean the instrument, wipe with a damp cloth using mild soapy solution.

TABLE OF CONTENTS

1.0	OVERVIEW	1
2.0	FEATURE LOCATIONS	1
3.0	LCD DISPLAY SYMBOLS	2
4.0	PLT200 SPECIFICATIONS	3
5.0	PREPARATION FOR MEASUREMENT	7
5.1	Non-Contact Preparation	7
5.2	Direct Contact Preparation	7
5.3	Connecting External Sensors	8
6.0	TACHometer Mode	9
6.1	TACHometer Setup	9
6.2	TACHometer Operation	11
7.0	RATE Mode	12
7.1	RATE Setup	12
7.2	RATE Operation	14
8.0	TOTALizer Mode	15
8.1	TOTALizer Setup	15
8.2	TOTALizer Operation	18
9.0	TIMER Mode	19
9.1	TIMER Setup	19
9.2	TIMER Operation	20
10.0	MAKING MEASUREMENTS	21
10.1	Non-Contact Measurements	21
10.2	Direct Contact Measurements	21
11.0	INPUT / OUTPUT	22
12.0	BATTERIES	23
13.0	CLEANING	23
14.0	OPTIONS/ACCESSORIES	24

1.0 OVERVIEW

The Pocket Laser Tach 200 is a precision hand-held multifunction Tachometer, Ratemeter, Totalizer and Timer. It is programmable to display directly in Revs, Inches, Feet, Yards, Miles, Centimeters and Meters or function as a stopwatch or interval timer. Input / output sockets allow for remote sensing and pulse output to external indicating devices. For ease of use, the instrument can be “Locked-on” for continuous operation.

2.0 FEATURE LOCATIONS

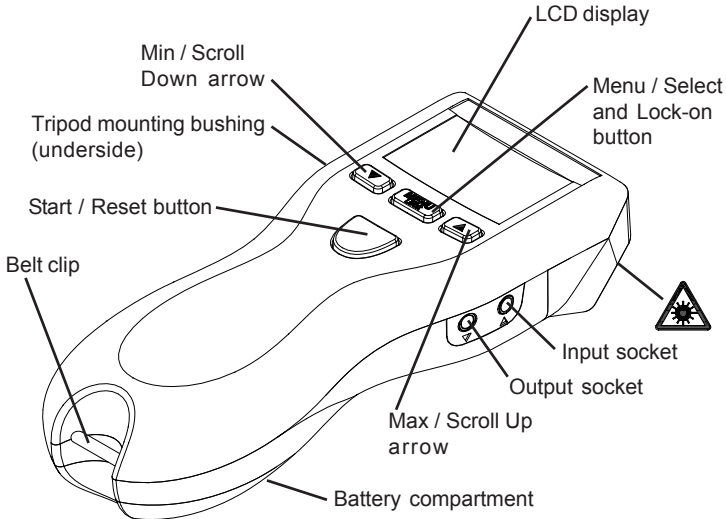

AVOID EXPOSURE - LASER RADIATION IS EMITTED FROM THIS APERTURE

11.0 INPUT / OUTPUT

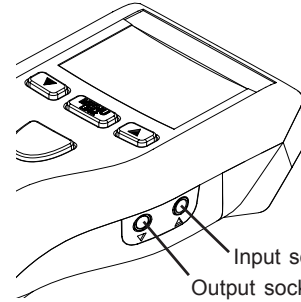

Input: Accepts remote sensor or Remote Contact Assembly (RCA). 1/8" (3.5mm) stereo phone plug.

Output: 1 pulse per revolution TTL output on internal operation. Pulse repeater with external sensors. 1/8" (3.5mm) mono phone plug.

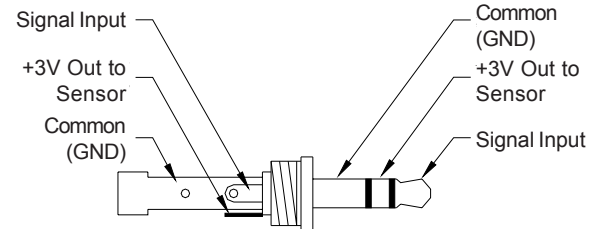

Input Connector Detail (Stereo plug)

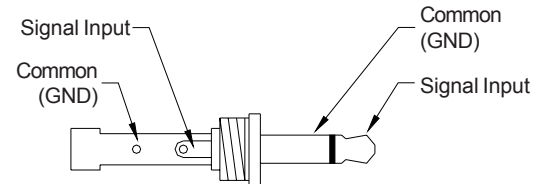

Output Connector Detail (Mono plug)

10.0 MAKING MEASUREMENTS

10.1 Non-Contact Measurements

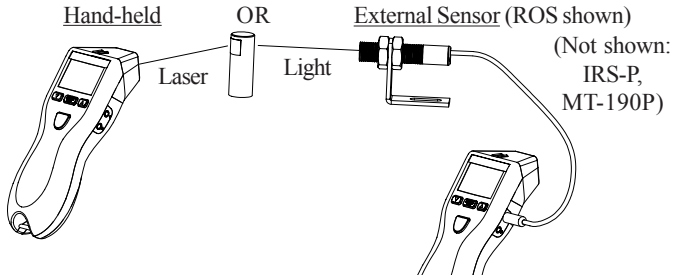

10.2 Direct Contact Measurements

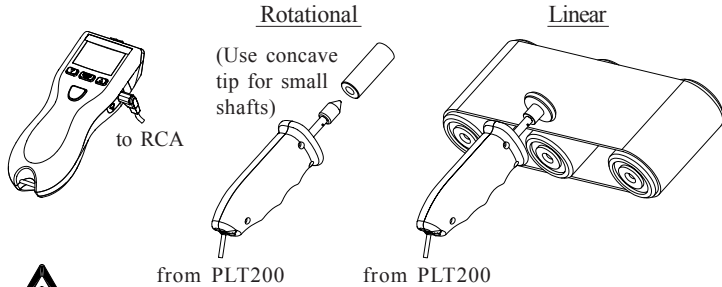



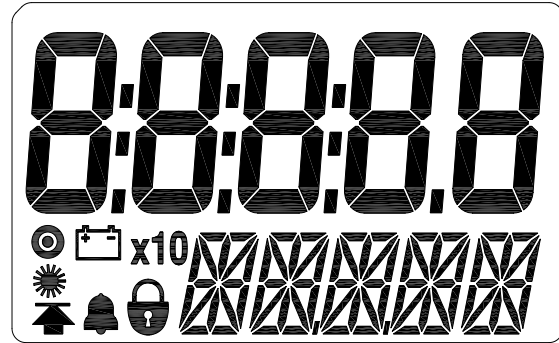

ONLY USE MODERATE PRESSURE

WARNING: Making measurements in direct contact with rotating equipment can be dangerous. Keep all loose clothing and hair away from exposed moving machinery. Keep the hand holding the instrument well behind the back end of the Remote Contact Assembly. Properly replace all machinery guards after completing measurement. Do not use for rotation greater than 20,000 RPM.

3.0 LCD DISPLAY SYMBOLS



-  On Target Indicator. Blinks on whenever there is an input signal. Will appear to be solid on at higher frequencies.
-  Low Battery icon. Indicates that the batteries are low and need to be replaced.
-  Times Ten icon. Indicates that the value shown is ten times that which is displayed.
-  Laser Indicator. Red laser is on when this indicator is illuminated.
-  Lock icon. Indicates that the unit is “Locked” on and making continuous measurements (Lock mode).

4.0 PLT200 SPECIFICATIONS

Laser Specifications:

Classification: Class 2 (per IEC 60825-1 Ed 1.2 2001-8)
Complies with FDA performance standards for laser products except for deviations pursuant to Laser Notice No. 50, dated July 26, 2001.

Maximum Laser Output: 1mW
Pulse Duration: Continuous
Laser Wavelength: 650 nm
Beam Divergence: < 1.5 mrad
Beam Diameter: 4 x 7 mm typical at 2 meters
Laser Diode Life: 8,000 operating hours MTBF (1 year warranty)

Non-Contact Specifications:

Ranges: RPM 5 – 200,000
RPS 0.084 – 3,333.3
RPH 300-999,990

Resolution: Fixed: 1 (10 above 99,999)
Auto-ranging: 0.001 to 1.0 (10 above 99,999)

Accuracy: ±0.01% of reading or resolution limit

Operating Range: up to 25 feet (7.62 m) or up to 70 degrees off perpendicular to T-5 tape target

Contact Specifications using optional Remote Contact Assembly:

Range: Contact Tips: 0.5 to 20,000 RPM
10 cm / 12-inch Wheel: 0.5 to 12,000 RPM



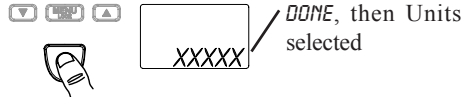

Resolution: Fixed: 1 (10 above 99,999)
Auto-ranging: 0.001 to 1.0 (10 above 99,999)

8. Save and advance 
9. Exit Setup – Ready to measure 

Unit will remember these settings (including lock on/off) even if turned off and back on.









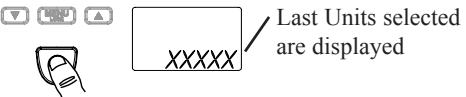

9.2 TIMER Operation

Measure:

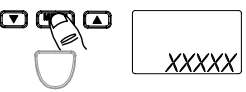
- Manual  Each press toggles Start and Stop
- Auto  OR Start and Stop triggered by Remote Optical Sensor (ROS)
- Reset  With Timer stopped - Resets time to 00:00.0
- Lap  With Timer running - Stops at elapsed time to date. To continue, press again.
- Power Off  OR Automatic after 90 seconds if unit not Locked on

9.0 TIMER Mode

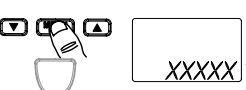
9.1 TIMER Setup

1. Turn Power ON  Last Units selected are displayed
- 1a. To toggle Lock On/Off  Press and Hold  Locked On
2. Enter Setup Mode  **SETUP**
3. Enter selection of Mode  Last Mode selected is displayed
4. Select TIMER Mode  OR  Repeat until **TIMER** displayed
5. Save and advance  **SETUP**
6. Enter selection of Timer function  **MAN** or **AUTO**
7. Select Timer function  OR  Toggles between Manual and Auto

Contact Specifications (continued):

Accuracy: Revs: $\pm 0.05\%$ of reading (RPM) or resolution limit (with no slippage)
 Linear: $\pm 0.5\%$ of reading or resolution limit (with no slippage)

Contact Measurements Ranges:

TACHOMETER:

Revolutions per Minute (RPM) 0.5 to 20,000 RPM
 Revolutions per Second (RPS) 0.0833 to 333.33 RPS
 Revolution per Hour (RPH) 30 to 999,990 RPH

RATES:

Wheel Circumference:

Inches per Second	10 cm: 0.033 to 1312.3 IPS
	12 in: 0.100 to 2,400.0 IPS
Inches per Minute	10 cm: 1.969 to 78,740 IPM
	12 in: 6.000 to 144,000 IPM
Inches per Hour	10 cm: 118.11 to 999,990 IPH
	12 in: 360.00 to 999,990 IPH
Feet per Second	10 cm: 0.003 to 109.36 FT/S
	12 in: 0.009 to 200.00 FT/S
Feet per Minute	10 cm: 0.164 to 6,561.7 FT/M
	12 in: 0.500 to 12,000 FT/M
Feet per Hour	10 cm: 9.843 to 393,700 FT/H
	12 in: 30.000 to 720,000 FT/H
Yards per Second	10 cm: 0.001 to 36.453 YPS
	12 in: 0.003 to 66.667 YPS
Yards per Minute	10 cm: 0.055 to 2,187.2 YPM
	12 in: 0.167 to 4,000.0 YPM

Contact Measurements Ranges (continued):

RATES:

Wheel Circumference:

Yards per Hour	10cm:	3.281 to 131,233 YPH
	12 in:	10.000 to 240,000 YPH
Miles per Hour	10 cm:	0.002 to 74.564 MPH
	12 in:	0.006 to 136.36 MPH
Centimeters per Second	10 cm:	0.084 to 3,333.3 CM/S
	12 in:	0.21 to 3,048.0 CM/S
Centimeters per Minute	10 cm:	5.000 to 200,000 CM/M
	12 in:	15.240 to 365,760 CM/M
Centimeters per Hour	10 cm:	300.00 to 999,990 CM/H
	12 in:	914.40 to 999,990 CM/H
Meters per Second	10 cm:	0.001 to 33.333 M/SEC
	12 in:	0.003 to 60.960 M/SEC
Meters per Minute	10 cm:	0.050 to 2,000.0 M/MIN
	12 in:	0.153 to 3,657.6 M/MIN
Meters per Hour	10 cm:	3.000 to 120,000 M/H
	12 in:	9.144 to 219,460 M/H

TOTALIZER:

Counts: 0 to 999,999

Scale Totals in Inches, Feet, Yards, Centimeters or Meters

Input: Internal or External optics or linear contact wheel



Timer Specifications:



Minutes:Seconds.Tenths to 99:59.9

Accuracy: ±0.2 second



Resolution: 0.1 second



8.2 TOTALizer Operation

Measure  OR 



 OR 



Press and hold Lock on

Recall Max or Min    Max or Min Speed (in last selected Tach or Rate mode units)







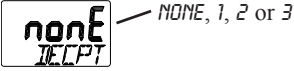

Recall Time in seconds    Shows time in seconds from when the Start / Reset button is pressed until the last input signal measured.

If unit is Locked on:  Resets Max/Min, Total and Measurement Time

Power Off   OR Automatic after 90 seconds if unit not Locked on

NOTE: Pressing  OR  once before 90 seconds will keep measurements in memory and the display turned on longer.

TOTALizer Setup (continued):

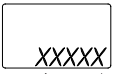
9. Enter selection of number of decimal places  
10. Select decimal places   OR   Repeat until desired decimal places displayed
11. Save and advance  
12. Exit Setup – Ready to measure  
Units = COUNT: Rotational/Linear Units:
DONE, *DONE,*
then Units selected *USE CONTACT TIP* or
[wheel selected],
then Units selected

Unit will remember these settings (including lock on/off) even if turned off and back on.

Display: 5 x 0.5" (12.7mm) numeric digits plus 5 Alpha-numeric LCD

Batteries: 2 "AA" 1.5 V  (DC) alkaline included
(Note: Batteries are NOT rechargeable.)

Battery Life: 30 hours continuous typical with batteries provided

External Input:

Absolute max: -0.3 V to 5 V  (DC)

Minimum: low below 1.2 V and high above 2 V (TTL compatible)

Edge: Triggers on Positive edge

Power Out: 3.0 V nominal, approx. 2.8 V @ 20 mA max

Pulse Output: 0 V to 3.3 V  (DC) pulse
Same shape as External Input signal or high when internal optics sees a reflection

Dimensions: 6.92" (17.58 cm) H x 2.4" (6.10 cm) W x 1.6" (4.06 cm) D

Weight: Approx. 7 oz. (210 g)

This product is designed to be safe for indoor use under the following conditions (per IEC61010-1).

Installation Category II per IEC 664

Pollution Degree Level II per IEC 664

Temperature: 40 °F to 105 °F (5 °C to 40 °C)

Humidity: Maximum relative humidity of 80% for temperatures up to 88 °F (31 °C) decreasing linearly to 50% relative humidity at 100 °F (40 °C). Humidity non-condensing.

Specifications subject to change without notice.

5.0 PREPARATION FOR MEASUREMENT

5.1 Non-Contact Preparation

For Internal operation (Red laser) or External operation using optional Remote Optical Sensor (ROS-Red LED).

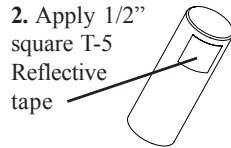

For Small Shafts:

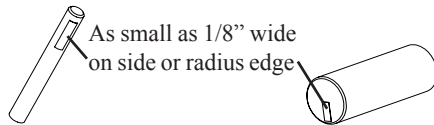

5.2 Direct Contact Preparation

For External operation ONLY using optional Remote Contact Assembly (RCA).

Select and install contact option:

1. Contact Tip (Convex tip shown. Use Concave tip for small shafts.)

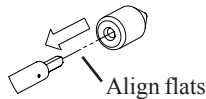

6. Enter selection of Units Different options displayed for Internal or External operation.

Internal or External ROS:

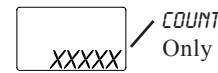

External RCA:

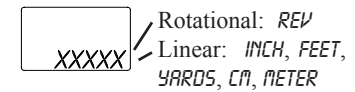

7. Select Units OR Repeat until desired Units displayed

8. Save and advance OR Linear Units

Only for Linear Units:

- 8a. Enter selection of Wheel Last Wheel selected is displayed

- 8b. Select Wheel OR Toggles between 10CM and 12IN

- 8c. Save and Advance

8.0 TOTALizer Mode

8.1 TOTALizer Setup

1. Turn Power ON  Different messages displayed for Internal or External operation.



Internal or External ROS:

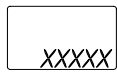

Last Units selected

External RCA:

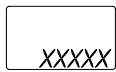

EXTRN, then scrolling message, then last Units selected

- 1a. To toggle Lock On/Off

Press and Hold

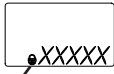

Locked On

2. Enter Setup Mode



3. Enter selection of Mode

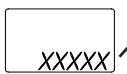

Last Mode selected is displayed

4. Select TOTAL Mode

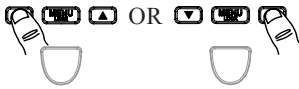

Repeat until TOTAL displayed.

5. Save and advance



2. 10 cm Wheel

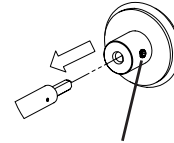

Tighten screw securely into flat on shaft.

OR

3. 12 inch Wheel

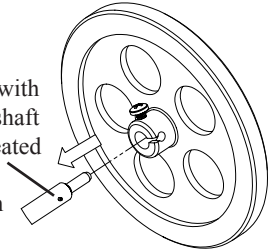

Install with pin in shaft fully seated in slot. Tighten screw.

5.3 Connecting External Sensors

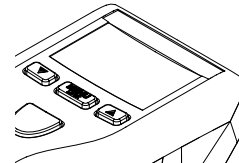

Plug sensor into Input socket



Remote Contact Assembly (RCA)
(shown with optional 12 inch wheel)



Remote Optical Sensor (ROS-P)



Infrared Sensor (IRS-P)





Magnetic Sensor with Amplifier (MT-190P)

6.0 TACHometer Mode



6.1 TACHometer Setup

1. Turn Power ON
 
 Last Units selected are displayed
- 1a. To toggle Lock On/Off

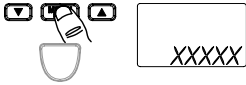
Press and Hold



 Locked On
2. Enter Setup Mode
 
3. Enter selection of Mode
 
 Last Mode selected is displayed
4. Select TACH Mode

OR

 Repeat until TACH displayed
5. Save and advance
 
6. Enter selection of Units
 
 RPS, RPM or RPH





11. Save and advance
 
12. Exit Setup – Ready to measure

DONE, USE CONTACT TIP or [wheel selected], then Units selected



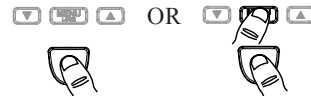

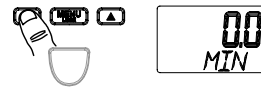



Unit will remember these settings (including lock on/off) even if turned off and back on.

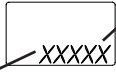







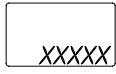

7.2 RATE Operation







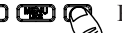







- Measure
- OR
- 
- Press and hold
- Lock on
- Recall Max
- 
- Max Speed
- Recall Min
- 
- Min Speed
- If unit Locked on:
- 
- Resets Max/Min
- Power Off
- OR Automatic after 90 seconds if unit not Locked on
- 

RATE Setup (continued):

6. Enter selection of Units   Rotational: *CRPS, CRPM or CRPH*
 Linear: *IPS, IPM, IPH, FT/S, FT/M, FT/H, YPS, YPM, YPH, MPH, CM/S, CM/M, CM/H, M/SEC, M/MIN, M/H*
7. Select Units  OR  Repeat until desired Units displayed 
8. Save and advance   OR 
 Rotational Units Linear Units



















Only for Linear Units:

- 8a. Enter selection of Wheel   Last Wheel selected is displayed
- 8b. Select Wheel  OR  Toggles between *10CM* and *12IN* 
- 8c. Save and Advance  
9. Enter selection of number of decimal places   NONE, 1, 2 or 3
10. Select decimal places  OR  Repeat until desired decimal places displayed 

7. Select Units  OR  Repeat until desired Units displayed 
8. Save and advance  
9. Enter selection of number of decimal places   NONE, 1, 2 or 3
10. Select decimal places  OR  Repeat until desired decimal places displayed 
11. Save and advance  
12. Exit Setup – Ready to measure   DONE, then Units selected

Unit will remember these settings (including lock on/off) even if turned off and back on.













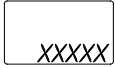



6.2 TACHometer Operation

- Measure  OR   OR 
- Press and hold  Lock on 
- Recall Max     Max Speed
- Recall Min     Min Speed
- If unit Locked on:   Resets Max/Min
- Power OFF   OR  Automatic after 90 seconds if unit not Locked on

7.0 RATE Mode

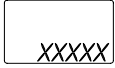
NOTE: External Remote Contact Assembly (RCA) must be inserted into input socket.

7.1 RATE Setup

- Turn Power ON    *EXTRN*, then scrolling message, then last Units selected
- To toggle Lock On/Off     Locked On
- Enter Setup Mode   
- Enter selection of Mode    Last Mode selected is displayed
- Select RATE Mode   OR   Toggles between *RATE* and *TOTAL*. Select *RATE*.
- Save and advance 