

Operating Instruction



HYDROMETTE BL

E



EN



GANN MESS- U. REGELTECHNIK GMBH

70839 GERLINGEN

SCHILLERSTRASSE 63

INTERNET: <http://www.gann.de>

Verkauf National: TELEFON 07156-4907-0
Verkauf International TELEFON +49 7156-4907-0

TELEFAX 07156-4907-40
TELEFAX +49 7156-4907-48

EMAIL verkauf@gann.de
EMAIL sales@gann.de

Table of contents

0.1	Publication Statement	5
0.2	General Notes.....	5
0.3	WEEE Directive 2002/96/EC Law on Electrical and Electronic Equipment.....	7
1	Introduction	7
1.1	Description	7
1.2	Device Layout and Button Assignment	8
1.3	Display Symbols.....	9
2	Basic Functions	10
2.1	Switch on Device.....	10
2.2	Display in Measuring Mode	11
2.3	Setting Menus.....	12
2.3.1	Measurement Menu (Main Menu).....	12
2.3.2	Material Setting.....	13
2.3.3	Maximum Value Display.....	14
2.3.4	Minimum Value Display.....	15
2.3.5	Memory Menu	16
2.4	Other Functions	17
2.4.1	Automatic Switch-off.....	17
2.4.2	Battery Monitoring	17
3	Specifications	18
3.1	Technical Data.....	18
3.2	Prohibited Environmental Conditions.....	18
3.3	Measuring Ranges.....	19

4	Application notes	20
4.1	General notes	20
4.2	Moisture measurement	20
4.2.1	M20 hammer electrode	21
4.2.2	M20-OF 15 surface measuring caps.....	21
4.2.3	M6 stick-in electrode.....	22
4.2.4	M6-HW 200/300 flat electrode pair.....	23
4.2.5	M21-100/250 depth electrodes	23
4.2.6	Contact paste.....	26
4.2.7	M20-Bi 200/300 stick-in electrode pair	26
4.2.8	M25-100/300 brush electrodes	27
4.2.9	External temperature sensors	27
4.3	Connecting the active electrode B 55 BL.....	28
4.3.1	General notes.....	28
4.3.2	Orientation values	29
4.3.3	Handling the active electrode B 55 BL.....	30
4.4	Equilibrium moisture content/household humidity	32
4.5	Wood moisture measurement.....	34
4.5.1	Hammer electrode M20.....	35
4.5.2	Surface measurement cap M20-OF 15	35
4.5.3	Stick-in electrode pair M20-HW 200/300.....	36
4.5.4	Ram-in electrode M18	36
4.6	Temperature compensation	37
4.7	Test adapter for wood moisture measurement	40
4.8	Static charge.....	40

4.9	Equilibrium wood moisture content.....	40
4.10	Growth ranges of fungi.....	41
4.11	Swelling and shrinkage of the wood	41
5	Appendix	42
5.1	Material table	42
5.2	Air humidity - material moisture comparison.....	44
6	Accessories.....	46

Graphical short operating instructions in the centre

0.1 Publication Statement

This publication replaces all previous versions. It may not be reproduced in any form or processed, duplicated or disseminated using electronic systems without the written permission of Gann Mess- u. Regeltechnik GmbH. Subject to technical and documentary changes. All rights reserved. This document was prepared with the required care. Gann Mess- u. Regeltechnik GmbH accepts no liability for errors or omissions.

GANN Mess- u. Regeltechnik GmbH, Gerlingen, Germany.
07/11/2014

0.2 General Notes

This measuring device fulfils the requirements of the applicable European and national directives (2004/108/EC) and standards (EN61010). Appropriate declarations and documentation are held by the manufacturer. To ensure trouble-free operation of the measuring device and operational reliability, the user must carefully read the operating instructions. The measuring device may only be operated under the climatic conditions specified. These conditions can be found in Chapter 3.1 "Technical data". This measuring device may likewise only be used under the conditions and for the purposes it was designed for. Operational reliability and functionality are no longer ensured if the device is modified or adapted. Gann Mess- u. Regeltechnik GmbH is not liable for any damage arising from such modifications or adaptations. The risk is borne by the user alone.

- Using appropriate means, make always sure that there are no electrical cables, water pipes, or other utility lines at the location, at which the measurement is to be carried out.

- The device must not be stored or operated in aggressive air or air containing solvents!
- Material that is frozen or has wet surfaces cannot be measured.
- The notes and tables in these instructions on permitted or normal humidity conditions in practice and the general definitions of terms have been taken from the specialist literature. No responsibility can therefore be taken by the manufacturer for the correctness of this information. The conclusions to be drawn from the measurement results are related to the individual conditions and the knowledge drawn from professional experience for each user.
- The measuring device may be operated in residential and commercial areas, as the stricter class B for emitted interference (EMC) has been adhered to.
- The device may not be operated in the immediate area of medical equipment (heart pacemakers, etc.).
- The measuring device may only be properly used as described in these instructions. Keep the device and accessories out of the reach of children!
- Measurements must not be carried out on metallic surfaces.

Gann Mess- u. Regeltechnik GmbH accepts no liability for damage resulting from non-adherence to the operating instructions or by not taking proper care during transport, storage or operation of the device, even if this requirement for care is not specifically addressed in the operating instructions.

0.3 WEEE Directive 2002/96/EC Law on Electrical and Electronic Equipment

Disposal of packaging, battery, and device must be undertaken in accordance with the legal requirements at a recycling centre.

The device was manufactured after 1 October, 2009

1 Introduction

1.1 Description

The Hydromette BL E is an electronic building humidity and wood moisture meter. By connecting the active electrode B 55 BL the non-destructive measurement of building moisture is also possible. The Hydromette BL E also includes the wood types 2&3 for the wood moisture measurement.

It is possible to measure the building moisture of various construction and insulating materials as well as various hard and soft woods. The Hydromette BL E can also be used to detect the moisture distribution in walls, ceilings and floors.

Through an additional connector, GANN IR surface or stick-in temperature sensors can be used.

The Hydromette BL E has a LCD display.

1.2 Device Layout and Button Assignment



1.3 Display Symbols

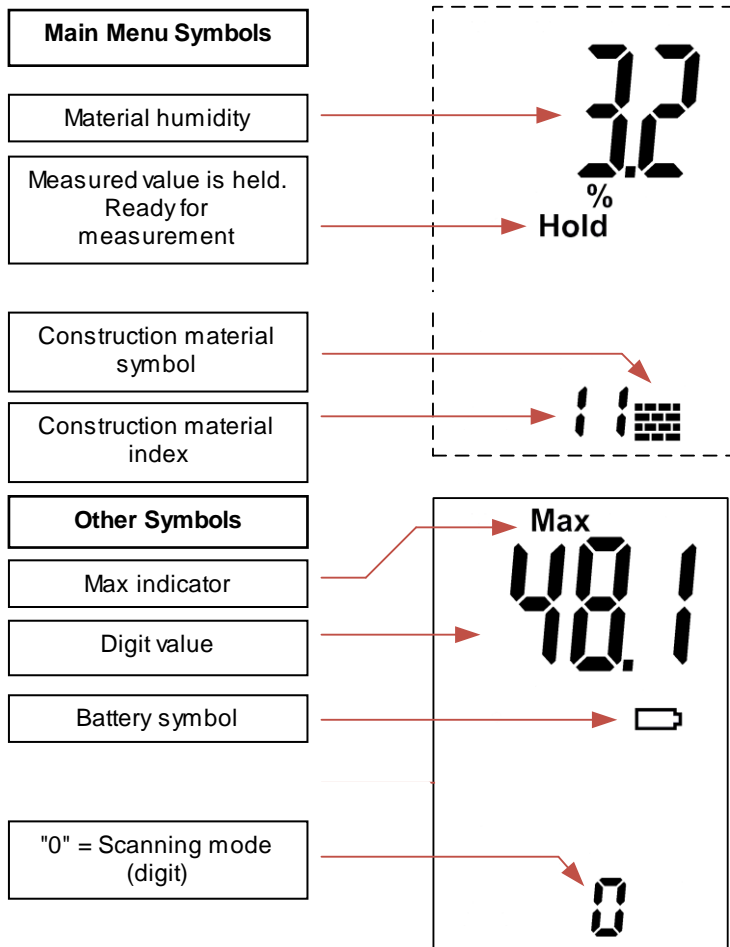

2 Basic Functions

2.1 Switch on Device

The unit is powered by pressing the **ON** button  .

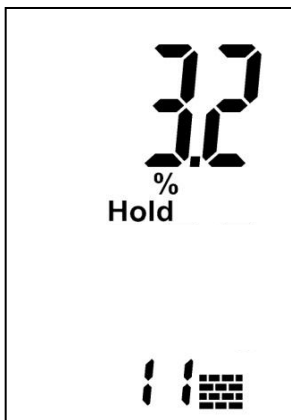

**Most recently measured material
humidity in %**

Material type set

Figure 2-1 Measurement menu

After pressing **ON**, the display changes to the measurement menu (the main menu). This menu is used to show the most recently measured values. The "Ready for measurement" information is shown by displaying "Hold" on the display.

2.2 Display in Measuring Mode

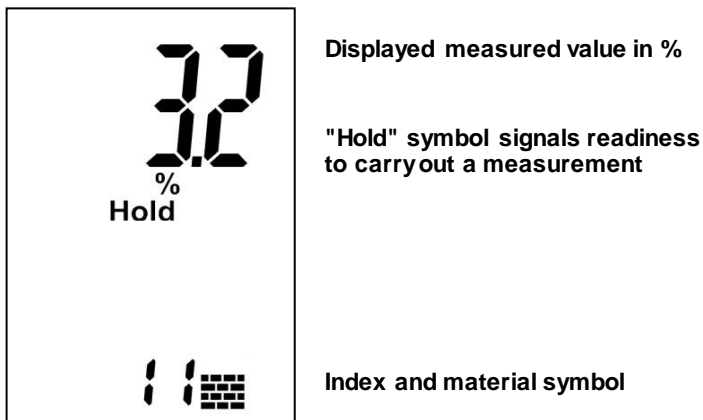

Figure 2-2 Measuring mode

A measurement process is started by pressing the **M** button.

The 0 type index for a measurement is shown in **Digits**. Scaling is then from 0 to 100, % character and material symbol will disappear. This value allows individual measurements or complete humidity profiles to be created, irrespective of the properties of the material to be measured.

Digit values are non-dimensional measured values and no real humidity values in %!

A measurement is initiated by pressing the **M** button for more than 1 second.

2.3 Setting Menus

From the measuring menu, repeatedly press the **Up** or **Down** button to select the following menu items one after another (use **Down** to select the menus in their order, use **Up** to select them in opposite order).

1. **Measurement menu** (main menu): Use to carry out the measuring process.
2. **Material setting**: Use to select the material type.
3. **Maximum value display**: The highest value measured is shown here.
4. **Minimum value display**: The lowest value measured is shown here.
5. **Memory menu**: The last 5 values measured can be called here.

2.3.1 Measurement Menu (Main Menu)

The last measurement with the note "**Hold**" is shown here. The device temperature and the current type are also shown on the display. When an external temperature sensor is connected, the sensor temperature is shown instead of the unit temperature.

In this menu, a new measurement can be started by pressing the "**M**" button.

During the measuring process, the "**Hold**" symbol disappears from the display. After releasing the "**M**" button, the measured value is saved. The "**Hold**" symbol is displayed again.

If the new measured value is larger than the previous maximum value, "**Max**" flashes on the display. If the value is not to be saved, the "**M**" button must be pressed *briefly*. If the value is to be saved, a new measurement is started with a *long* press on the "**M**" button without changing the previous maximum values.

2.3.2 Material Setting

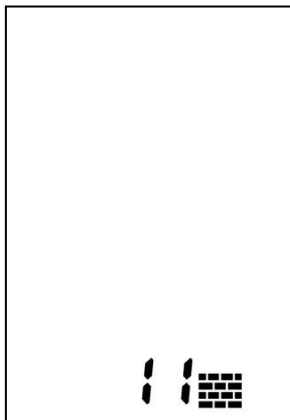

The material index set is displayed together with the symbol for the material moisture.

Index and material symbol

Figure 2-3 Material selection

If the preset material is to be changed, the "M" button (measurement button) must be pressed *momentarily*.

The Material index flashes and can be set using the **Up** or **Down** buttons. The change is saved by pressing the "M" button again *briefly*.

The material table is found in the Appendix.

2.3.3 Maximum Value Display

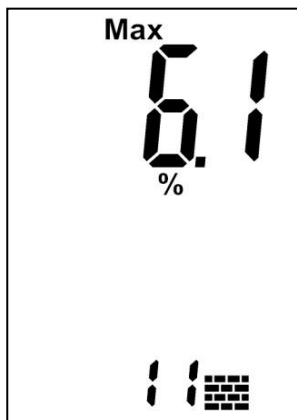

The highest measured value of a measurement series is displayed together with the "Max" display symbol

Index and material symbol

Figure 2-4 Maximum value menu

If a maximum value is to be deleted, the displayed value must be selected by *momentarily* pressing the "M" button (measurement button).

The value flashes and can now be deleted using a *long* press on the "M" button.

Afterwards, only the "Max" symbol is still flashing. Using another *momentary* press on "M" button, the entry is confirmed and the device returns to the Ready mode.

Using the "M" button, a new measurement can then be carried out immediately.

2.3.4 Minimum Value Display

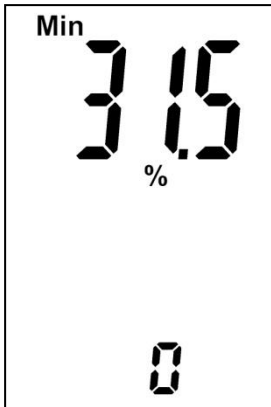

The lowest moisture measurement in a measurement series is displayed together with the "Min" display symbol

Type index

Figure 2-5 Minimum value

If a minimum value is to be deleted, the displayed value is selected by *momentarily* pressing the "M" button.

The value and the % symbol now flash and the value can be deleted by a *long* press on the "M" button. After deleting the value, only the % symbol still flashes. By *momentarily* pressing the "M" button again, the deletion of the value is confirmed and the % symbol disappears. The device now returns to Ready mode.

Using the "M" button, a new measurement can then be carried out.

2.3.5 Memory Menu

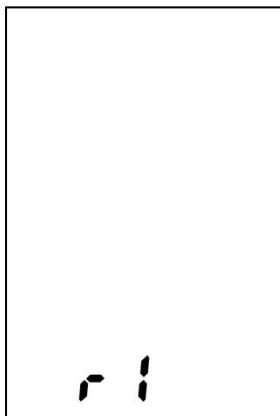

Symbol: memory "r1"

Figure 2-6 Memory location "r1"

As soon as you select the memory menu, the memory location number "r1" is displayed for approx. 1 second, and then the last measured saved value contained there is displayed.

The last 5 measured values are automatically saved and stored in memory locations "r1" to "r5". The last measured value is in memory location "r1". This is a ring buffer: Once the sixth measured value is recorded, the first measured value is automatically removed from the memory.

By *momentarily* pressing the "M" button, the next memory location "r2" is selected and the value contained there is displayed. After reaching the 5th memory location, the first one is shown again.

The saved values displayed can be identified by the fact that **no "Hold"** symbol is shown in the display.

2.4 Other Functions

2.4.1 Automatic Switch-off

If no button is pressed within approx. 30 seconds, the device switches off automatically. The current values are retained and are displayed again after the unit is switched back on.

2.4.2 Battery Monitoring

If the battery symbol  appears in the display, the battery is dead and must be renewed.

A list of battery types that can be used can be found in the "Technical data" chapter.

3 Specifications

3.1 Technical Data

Display:	3-line display
Display resolution:	0.1 %
Response time:	< 2 s
Storage conditions:	+ 5 to + 40 °C - 10 to + 60 °C (short-term)
Operating conditions:	0 to + 50 °C - 10 to + 60 °C (short-term)
Power supply:	9V block battery
Approved types:	6LR61 type or 6F22 type
Dimensions:	(L x W x H) 190 x 50 x 30mm
Weight:	approx. 160g

3.2 Prohibited Environmental Conditions

- Condensation, air humidity continuously too high (> 85 %) and wetness
- Permanent presence of dust and combustible gases, fumes or solutions
- Ambient temperatures continuously too high (> +50 °C)
- Ambient temperatures continuously too low (< 0 °C)

3.3 Measuring Ranges

0 to 100 digits

0.1 to 42.2 wt.-%, depending on material to be measured

0.2 to 9.9 CM-%, depending on material to be measured

Wood moisture measurement:

5,5% to 58% (depending on variety)

Optional external temperature sensor:

ET 100 BL (order no. 13165): -50 to +250 °C

OT 100 BL (order no. 13170): -50 to +250°C

TT 40 BL (order no. 13180): -50 to +350°C

4 Application notes

4.1 General notes

The Hydromette BL E is an electrical measuring instrument the operation of which is based on the principle of resistance measurement. The unit is used to determine the degree and distribution of humidity in construction materials such as masonry, concrete, floor screed, insulating materials etc. as well as their temperatures. In addition, the Hydromette BL E includes the wood types 2&3 for the wood moisture measurement.

4.2 Moisture measurement

Depending on the measuring task to be carried out, the unit can be used in conjunction with different electrodes. The electrodes must be connected to the measuring instrument using the appropriate MK8 measuring cable. On the instrument side, the cable is fitted with a BNC plug. The outer retaining ring of the plug is to be rotated clockwise until it engages, when the plug is attached to the measuring instrument. When disconnecting the cable, rotate the retaining ring anti-clockwise and pull the plug backward. Do not apply excessive force and do not pull the cable when disconnecting the plug!

In soft construction materials, the M20 electrode should be used, while the M6 or M 21-100 electrode pairs should be applied to floor screed or concrete using a contact agent.

For depth measurements in concrete or masonry up to 25 cm, the M 21-250 electrode pair is available. For measuring insulated flat roofs, back-vented facades, or half-timbered buildings, the M 20-Bi electrode can be used with 200 mm or 300 mm long insulated tips fitted to the shank.

For surface measurements, e.g. on concrete etc., special measuring caps (M 20-OF 15 model) are available. These can be used only in combination with the M 20 electrode.

4.2.1 M 20 hammer electrode

For depth measurements in soft and set construction materials (gypsum, plaster, Ytong brand etc.) up to a maximum of 70 mm in depth, tap the electrode with both needles into the material to be measured (the electrode body is made of impact-resistant plastic). Make sure that the full length of both tips of the electrode is placed only in that part of the construction material that is to be measured.

When removing the electrode, the needles can be loosened by slightly moving the electrode to the side. Where possible, the lock nuts should be tightened using a spanner or pliers before beginning a measurement series. Loose electrode pins will break easily.

When the measuring instrument is initially delivered with an M 20 electrode fitted, 10 replacement pins of 16 and 23 mm in length each are included. These are suited for measuring up to a maximum of 20 or 30 mm in depth. If measurements are to be carried out in greater depths, the electrode needles can be replaced by longer designs (40 or 60 mm). However, the risk of broken needles will increase with these needles.

4.2.2 M 20-OF 15 surface measuring caps

For surface measurements on smooth materials, the two hex lock nuts are to be removed and to be replaced by the surface measuring caps. For measuring, firmly press the two contact faces onto the material to be measured. The measuring depth is approx. 3 mm. Any particles adhering to the measuring surface must be regularly removed. If the elastic, plastic measurement sensors are

damaged, they can be reordered (no. 4316) and glued on using standard cyanate-based instant adhesive.

Warning:

Any surface contaminants (e.g. formwork release oil) may cause errors.

4.2.3 M 6 stick-in electrode

The two electrodes that are intended to measure set construction materials only are to be pushed into the material to be measured with approx. 10 cm clearance. Where this is not possible because of the hardness of the material to be measured (floor screed, concrete etc.), holes of approx. 6 mm in diameter are to be drilled and to be filled using contact agent. Then the tips of the two electrodes are to be pushed into the contact agent. Generally, both electrodes are to be applied to the **same** contiguous material to be measured.

When the M 6 stick-in electrodes are initially delivered, 10 replacement pins of 40 and 60 mm in length each are included. These are suited for measuring up to a maximum of 50 or 70 mm in depth. The lock nuts should be tightened using a spanner. To ensure proper contact, particularly make sure that the pre-drilled holes are completely filled in their full depth.

Warning:

When tapping the electrodes into hard construction materials (floor screed, concrete, etc.) without using contact agent, significant deviations in the measured values may result (low measured value).

4.2.4 M 6-HW 200/300 flat electrode pair

These two probes that are intended only for measuring the insulation material through the wall sealing joint of the floor screed are to be pushed off the floor screed edge joint down to the insulation material keeping a clearance of 5 to 10 cm. It is important to do this with care. The heat shrinkable tubing on the probes must not be damaged. Otherwise, measuring errors will result when measuring in humid floor screed. The lock nuts should be tightened using a spanner or pliers.

The probes are designed to be used only in conjunction with the M 6 electrode pair.

4.2.5 M 21-100/250 depth electrodes

The two electrodes that are intended to measure set construction materials only allow measurements to be carried out down to depths of maximum 100 or 250 mm. The insulated sleeves prevent the measuring results from being corrupted by higher surface humidity levels caused by thaw or rain.

Two blind holes of $\varnothing 8$ or 10 mm are to be drilled approx. 10 cm apart (the measuring section must be contiguous and consist of the same material).

Both very sharp drill and low speed are of high importance. If the drilled hole is hot after drilling, wait at least 10 minutes before inserting the electrodes or the contact agent. Vertically insert the pipe tip into the contact agent for 30 mm and remove the tip filled with the contact agent. Clean the electrode pipe up to the tip and insert it into the blind hole up to the stop.

Prepare the second hole in the same way. Connect the electrode rod to the bunch plug of the measuring cable and insert it into the electrode pipe. By pushing the rod, press the contact agent down the drilled hole up to its end. Connect the measuring cable to the

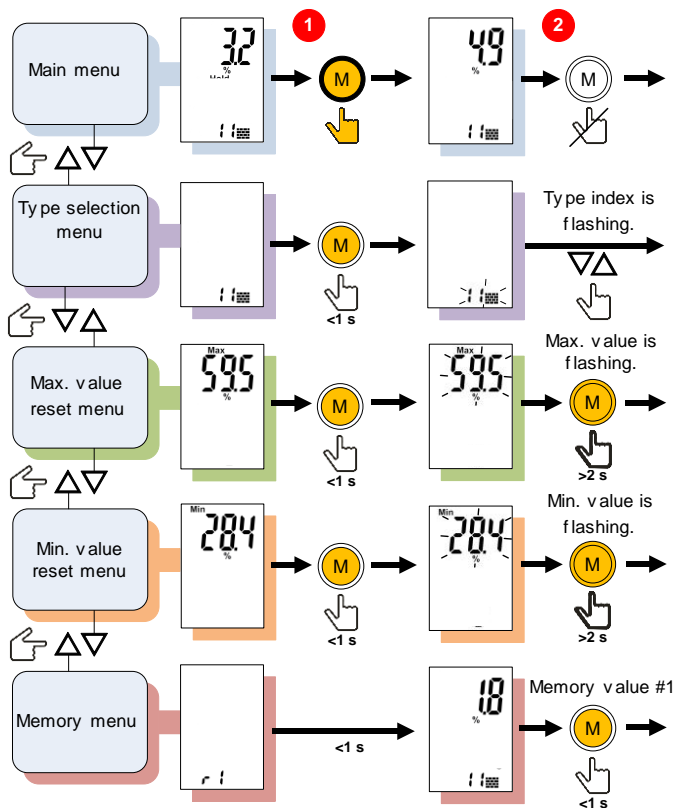

 ON/OFF button: The device deactivates after 40 s of inactivity.

 Press the measurement button for any amount of time.

 Release the measurement button.

 Hold the measurement button depressed for more than 2 seconds.

 Press the measurement button momentarily.

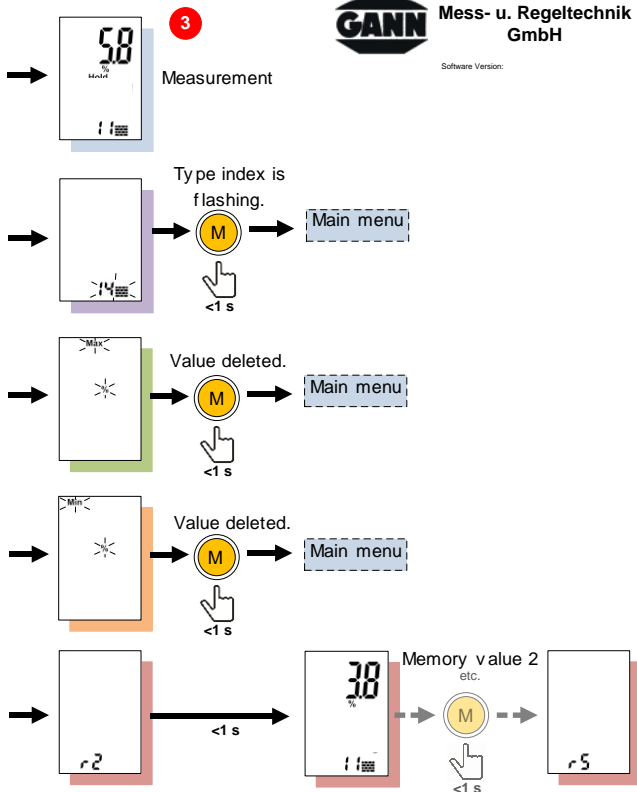

Press the "Up" or
"Down" buttons.



"Up" or "Down" for
menu selection.

How to carry out an easy measurement:

Switch on the device, the main menu will be displayed. 1

Hold the measurement button depressed for any amount of time. 2

Release the measurement button, the measured value will be retained. 3

measuring instrument, press the measurement button, and read the measured value (digits).

Warning:

The measured values may be corrupted, if the electrode pipe is excessively filled by contact agent or if an electrode pipe to which contact agent adheres is repeatedly removed and inserted.

4.2.6 Contact paste

The contact agent is supplied in a screw cap plastic container containing approx. 400/450g. It is used to provide proper contact between the electrode tip and the construction material to be measured or to additionally extend the electrode tips (M6 electrode). The water contained in the highly conductive agent is added to the material to be measured to replace the humidity that was displaced by the drilling process.

Because of the high conductivity, make sure that the contact agent is not spread across the surface of the material to be measured. When using the M 6 electrodes, it is useful to build a thin string from an appropriate amount of contact agent and to push this string into the drilled hole using the rear side of the drill bit.

By adding drinking water, the contact agent can always be kept in a condition, in which it is able to be worked. In general, the quantity of the contact agent will last for 30 to 50 measurements.

4.2.7 M 20-Bi 200/300 stick-in electrode pair

It is designed to carry out depth measurements on the beams in old buildings or half-timbered houses, particularly for determining moisture in insulated flat roofs and on insulated or back-vented facades.

To prevent the insulation of the tips from being damaged, electrodes should not be driven through construction materials of higher hardness levels (plaster, drywall panels etc.). Of course, insulating materials such as foamed polystyrene or mineral wool may be penetrated. Otherwise, use a Ø10mm drill bit for pre-drilling. Any corrupting impact is eliminated to a large extent by the insulated tips.

Remove the hex lock nuts together with the standard electrode tips from the M 20 electrode and replace by M 20-Bi electrode tips. Tighten them firmly!

4.2.8 M 25-100/300 brush electrodes

The two stainless steel brush electrodes are specially designed for depth measurements on hard and soft construction materials without using additional contact agents. For carrying out the measurement, two Ø6mm holes are to be drilled 10 cm apart. To obtain sufficient contact, the holes must be at least 2 cm in depth. Both electrodes must be applied to the same contiguous material to be measured. When measuring floor screed, the holes are to be drilled to 75% of floor screed thickness. To achieve long service life, the electrodes should always be rotated clockwise when inserting or removing them. Be careful when using pliers etc.

4.2.9 External temperature sensors

Using the additional connector, various temperature sensors (ET 100 BL stick-in sensors or IR 40 BL surface temperature sensors) may be connected to the Hydromette BL E unit. Once one of these sensors is connected to the unit, the device temperature shown in the display will be replaced by the sensor temperature. The "new" sensor temperature is updated by pressing the "M" button.

4.3 Connecting the active electrode B 55 BL

4.3.1 General notes

The active electrode B 55 BL is a non-destructive moisture indicator. It can be used for the detection of moisture distribution in building materials such as masonry, concrete plaster, wood, insulation materials etc.

The measurement is based on the measuring principle of the capacitive electric field. The measuring field is formed between the active ball on the top side and the assessed ground mass. The change of the electric field due to material and humidity is measured and displayed digitally (digits).

The measurement is a relative measurement, which means that the difference between the dry and the wet building materials is shown.

A conclusion on the absolute humidity in percent by weight or to the humidity after CM-percentage is only possible in normal course of dehydration.

In conjunction with the B 55 BL the Hydromette BL E works in the digital scan mode (grade 0).

4.3.2 Orientation values

The following data serve as a an orientation guide for anticipated display values:

Residential spaces

Dry 20 – 40 digits

Moist 80 – 140 digits

Cellars (old buildings)

Dry 40 – 60 digits

Moist 100 – 150 digits

Caution:

Dew point underflow or condensation on the surface which is measured can cause higher values and thus make the wall appear more moist than is really is!

Therefore it is useful to carry out an additional room air detector and dew point calculator (like the active-electrode TF-IR BL). This can prevent misinterpretations.

Depending on raw density, readings over 130 digits indicate that condensation is beginning.

Depending on the height of the covering, metal in the subsurface (iron reinforcements, wires, pipes, stucco bars, etc.) can raise the measurement value. This should be considered when evaluating the displayed values in relation to the covering.

4.3.3 Handling the active electrode B 55 BL

It is important to hold the active electrode on the rear half to prevent any influence to the measurement. The front half of the active electrode must remain free.

Right handling of the active electrode:



Figure 4-1 Correct handling

Wrong handling:



The hand of the operator influences the measurement field of the ball electrode and changes the measured value as it is shown in figure 4-2.

Figure 4-2 Wrong handling

Measuring

Press the measurement key “m” of the BL E and scan the area to be inspected. The electrode must rest firmly on the building material and should be held as vertically as possible (about 90°C). In corner areas, a margin of about 8-10 cm to the edge should be maintained.



4.3.4 Display digits in percentage by weight or CM-percent

Reading in digits	40	50	60	70	80	90	100	110	120	130
Cement screed wt. %	1,8	2,2	2,7	3,2	3,6	4,1	4,5	5,0	5,5	5,9
CM %	0,7	1,0	1,4	1,8	2,1	2,5	2,9	3,2	3,6	4,0
Anhydrite screed in wt. %	0,1	0,3	0,6	1,0	1,4	1,8	2,2	2,5	2,9	3,3
CM %	0,1	0,3	0,6	1,0	1,4	1,8	2,2	2,5	2,9	3,3
Concrete B15, B25, B35 wt. %	1,3	1,9	2,5	3,2	3,8	4,4	5,0	5,6	6,2	6,8
CM %	0,3	0,8	1,3	1,7	2,2	2,7	3,2	3,7	4,2	4,7
Cement mortar in wt. %	1,8	2,7	3,5	4,6	6,0	7,0	7,8			
CM %	0,6	1,5	2,3	3,1	4,0	4,8	5,6			
Lime mortar in wt. %	0,6	2,0	3,3	4,5						
CM %	0,6	2,0	3,3	4,5						
Lime-cement mortar in wt. %	2,2	3,6	5,0	6,4	7,8	9,2	10,6	11,0		
CM %	1,5	2,7	4,0	5,2	6,4	7,6	8,8	10,0		
Gypsum plaster in wt. %	0,3	0,5	1,0	2,0	3,5	6,5	10,0			
CM %	0,3	0,5	1,0	2,0	3,5	6,5	10,0			

The weight percentages and CM percentages calculated and directly displayed by the instrument are benchmarks. They relate to a normal drying process with natural reductions in moisture between the accessible depth, depending on the raw density. If the building material dries too quickly (due to warm air, dehumidifiers, floor heating, etc.) the measurement values may be displayed too low because of low surface moisture.

The depth effect is largely dependent on the respective raw density and surface moisture. Normal plaster and screed thickness are used when programming the values into the instrument.

Caution:

The notes and charts on allowable or common moisture conditions in practices and general definitions given in these instructions were taken from the technical literature; the instrument's manufacturer can therefore not guarantee their accuracy. The conclusions drawn from the measurement results depend on each user's individual requirements and practical professional empiricism.

4.4 Equilibrium moisture content/household humidity

The equilibrium values generally mentioned refer to a temperature of 20 °C and 65 % relative humidity. These values are often referred to as "household humidity" or as "air-dry". However, these should not be confused with the values at which the material can be handled and processed.

Flooring and floor screeds must be considered and evaluated in conjunction with the respective permeability of the material used. For example, when laying PVC flooring, the later average equilibrium moisture content is to be taken as the basis, i.e. the flooring can be laid in a centrally heated room, in which anhydrite screed is laid, only after the humidity has reached a value of approx. 0.6 wt.-%.

However, wooden parquet may be laid on concrete screed in a stove-heated room already in a humidity range between 2.5 and 3.0 wt.-%.

When evaluating wall surfaces, the respective long-term environmental conditions must also be considered. The lime mortar plaster in an old vaulted cellar can easily have a moisture content of 2.6 percent by weight, whereas the gypsum plaster in a centrally heated room having a moisture content of 1 wt.-% would have to be considered as to be too humid.

When evaluating the moisture in building material, the surrounding climate is the primary consideration. All materials are subject to continuously changing temperatures and air humidity. The influence of the material moisture significantly depends on the thermal conductivity, the thermal capacity, the resistance to water vapour diffusion and the hygroscopic properties of the material.

The "expected moisture content" of a material is the moisture level that corresponds to the average of the equilibrium moisture content under changing climatic conditions that it is continuously exposed to. The air humidity values in living areas in central Europe in the summer are approx. 45 - 65 % rel. humidity and in winter approx. 30 - 45 % rel. humidity. Increased damage occurs in centrally heated rooms in winter as a result of these variations.

It is not possible to specify generally applicable values. Rather, both technical and expert experience is required to correctly evaluate the measured values.

4.5 Wood moisture measurement

The Hydromette BL E works on the electrical resistance/conductivity measurement process known for years. This process is based on the fact that the electrical resistance is heavily dependent on the respective wood moisture.



Figure 4-3 Measuring across the fibre direction with M 20

The conductivity of oven-dried wood is very low, or the resistance so high that no current worth mentioning can flow. The more water is present, the greater the conductivity of the wood, or the lower the electrical resistance.

To achieve the qualitatively best possible measurement results, the wood used for the sample should be measured at multiple points. To do so, the electrode pins must be inserted across the fibre direction to between 1/4 and 1/3 of the overall thickness of the wood. To prevent measurement errors and breakage of the measuring pins, the hex nuts must always be well-tightened and the area between the pin holders kept clean.

The measurement of frozen wood is not possible.

4.5.1 Hammer electrode M 20

The electrode is hammered into the wood to be measured with the needles across the fibre direction (electrode body is made of impact resistant plastic). When removing, light sideways movements at right angles to the fibres can be used to loosen the needles.

To determine the core moisture content, the electrode pins must reach to between 1/4 and 1/3 of the overall wood thickness.

On delivery of the measuring device with electrode M 20, 10 replacement pins each of 16 and 23 mm length are included. These are suited for measuring wood thicknesses up to a max. of 30 and 50 mm respectively.

If thicker wood is to be measured, the electrode needles can be replaced with a suitably longer version. With increasing needle length, however, increased danger of breakage or bending (particularly when pulling out) must be expected. It is therefore recommended to use the M 18 ram-in electrode for thicker or particularly hard woods.

Where possible, the hex nuts should be tightened with a spanner or pliers before beginning a measurement sequence. Loose electrode pins break easily.

4.5.2 Surface measurement cap M 20-OF 15

Surface measurements should only be made with wood moisture levels under 30 %. For surface measurements on workpieces that have already been processed, or for measuring veneers, both hex nuts on the M 20 electrode are unscrewed and replaced with the surface measurement caps. For the measurement, both contact surfaces are pressed onto the workpiece to be measured or onto the veneer at right angles to the fibre direction. The measurement depth is approx. 3 mm, therefore multiple sheets of veneer must be laid on top of each other for the measurement. Do not measure on

metal surfaces! When measuring stacks of veneer, to unearth the measuring point, the veneer is **lifted** and **not pulled** over the remaining stack (**avoid friction: electrostatic charge!**). Wood particles adhering to the measuring surface must be regularly removed. If the elastic, plastic measurement sensor is damaged, they can be reordered (no. 4316) and glued on using standard cyanate-based instant adhesive.

4.5.3 Stick-in electrode pair M 20-HW 200/300

If the hex nuts with standard electrode pins on the M 20 electrode are removed, they can be replaced with the M 20-HW electrode pins. These must be fastened tightly!

For measurements in shavings and wood wool, it is advisable to compact the material to be measured a little. To do so, wood shavings should be pressed together with a weight of approx. 5 kg. No compression is necessary for balls of wood wool.

4.5.4 Ram-in electrode M 18

Both needles of the ram-in electrode are to be hammered to the required measurement depth at right angles to the fibre direction with the slide hammer. To determine the core moisture content, the electrode pins must reach to between 1/4 and 1/3 of the overall wood thickness.

Pulling out the needles is also done with the slide hammer with the impact direction upwards. Where possible, the hex nuts should be tightened with a spanner or pliers before beginning a measurement sequence. Loose electrode pins break easily.

**Warning:**

Do not completely drive in the electrode pins. There should be approx. 4 - 5 mm space between the wood surface and the hex nut. This is especially true when using Teflon-insulated pins.

When delivered, ram-in electrode M 18 is supplied with 10 replacement pins of 40 and 60 mm length (not insulated). These are suited for measuring wood thicknesses up to approx. 120 and 180 mm respectively.

If wood is to be measured with a large difference in the spread of moisture (e.g. accumulations of water), we recommend the use of Teflon-insulated electrode pins, which enable very precise measurement of zones and layers.

Figure 4-4 ram-in electrode M 18

They can be supplied in packets of 10 in lengths of 45 mm (order no. 4450) and 60 mm (order no. 4500).

4.6 Temperature compensation

The adjustment of the device is tuned to a wood temperature of 20°C. For different temperatures, the measurement results by this table can be corrected:

Readings																
	4	5	6	7	8	9	10	11	12	13	14	15	16	17		
-10	7.0	8.5	9.5	11.0	12.0	13.5	14.5	16.0	17.0	18.5	19.5	20.5	22.0	23.0		
-5	6.5	7.5	9.0	10.0	11.0	12.5	13.5	15.0	16.0	17.5	18.5	19.5	20.5	22.0		
0	6.0	7.0	8.5	9.5	10.5	11.5	13.0	14.0	15.0	16.5	17.5	18.5	19.5	21.0		
+5	5.5	6.5	7.5	8.5	9.5	11.0	12.0	13.0	14.0	15.0	16.5	17.5	18.5	20.0		
+10	5.0	6.0	7.0	8.0	9.0	10.5	11.5	12.0	13.0	14.0	15.5	16.5	17.5	19.0		
+15	4.5	5.5	6.5	7.5	8.5	9.5	10.5	11.5	12.5	13.5	14.5	15.5	16.5	18.0		
+20	4.0	5.0	6.0	7.0	8.0	9.0	10.0	11.0	12.0	13.0	14.0	15.0	16.0	17.0		
+25	2.4	4.5	5.5	6.5	7.5	8.5	9.5	10.5	11.5	12.5	13.5	14.5	15.5	16.5		
+30	3.0	4.0	5.0	6.0	7.0	8.0	9.0	9.5	10.5	11.5	12.5	13.5	14.5	15.5		
+35	2.5	3.5	4.5	5.5	6.5	7.5	8.5	9.0	10.0	11.0	12.0	13.0	14.0	15.0		
+40	2.5	3.5	4.0	5.0	6.0	7.0	7.5	8.5	9.5	10.5	11.5	12.0	13.0	14.0		
+45	2.0	3.0	3.5	4.5	5.5	6.5	7.5	8.0	9.0	10.0	11.0	11.5	12.5	13.0		
+50	2.0	2.5	3.0	4.0	5.0	6.0	7.0	7.5	8.5	9.5	10.5	11.0	12.0	12.5		
+55	1.5	2.5	3.0	4.0	5.0	5.5	6.5	7.0	8.0	9.0	9.5	10.5	11.5	12.0		
+60	1.0	2.0	2.5	3.5	4.5	5.0	6.0	6.5	7.5	8.5	9.0	10.0	10.5	11.5		

Wood temperature in °C

Real wood moisture in %

		Readings											
		18	19	20	21	22	23	24	25	26	27	28	29
-10	24.5	25.5	27.0	28.0	29.5	30.5	32.0	33.0	34.5	35.5	36.5	38.0	39.0
-5	23.0	24.0	25.5	26.5	28.0	29.0	30.5	31.5	32.5	34.0	35.0	36.0	37.0
0	22.0	23.0	24.5	25.5	26.5	27.5	29.0	30.0	31.0	32.5	33.5	34.5	35.5
+5	20.5	21.5	23.0	24.0	25.0	26.0	27.5	28.5	29.5	31.0	32.0	33.0	34.0
+10	19.5	20.5	22.0	23.0	24.0	25.0	26.0	27.0	28.0	29.5	30.5	31.5	32.5
+15	19.0	20.0	21.0	22.0	23.0	24.0	25.0	26.0	27.0	28.0	29.0	30.0	31.0
+20	18.0	19.0	20.0	21.0	22.0	23.0	24.0	25.0	26.0	27.0	28.0	29.0	30.0
+25	17.0	18.0	19.0	20.0	21.0	22.0	23.0	24.0	25.0	26.0	27.0	27.5	29.0
+30	16.5	17.0	18.0	19.0	20.0	21.0	22.0	23.0	24.0	25.0	25.5	26.5	27.5
+35	16.0	16.5	17.5	18.0	19.0	20.0	21.0	22.0	23.0	24.0	24.5	25.5	26.5
+40	15.0	15.5	16.5	17.5	18.5	19.5	20.0	21.0	22.0	23.0	23.5	24.5	25.5
+45	14.0	15.0	15.5	16.5	17.5	18.5	19.0	20.0	21.0	22.0	22.5	23.5	24.5
+50	13.5	14.5	15.0	16.0	17.0	18.0	18.0	19.5	20.5	21.0	22.0	22.5	23.5
+55	13.0	13.5	14.5	15.0	16.0	17.0	17.5	18.5	19.5	20.0	21.0	21.5	22.5
+60	12.5	13.0	14.0	14.5	15.5	16.5	17.0	18.0	19.0	19.5	20.5	21.0	22.0
Wood temperature in °C		Real wood moisture in %											

4.7 Test adapter for wood moisture measurement

With the test adapter supplied with order no. 6070 for checking the wood moisture measuring element, the functionality of the device, measurement cable and electrodes M 18 and M 20 can be tested.

For this, the device is connected with measurement cable MK 8 and the 4-mm plug of the cable in the socket of the test adapter.

The device must be set to wood type 4 and manual temperature compensation set to 20 °C. No active sensor may be connected. The display should show 21 % at top right in the first line. A deviation of +/- 0.5 % is permitted.

4.8 Static charge

At low levels of air humidity aided by external factors (friction during material transport, high insulation of the surrounding area), static electricity can build up with high voltages, which can not only lead to strong swings in measured values or minus values, but also to the destruction of electronic components in the device. The operator of the measuring device can also, unintentionally, contribute to the build-up of static charge from his/her clothing. A significant improvement can be achieved by ensuring the operator and the measuring device remain completely still during the measurement process and by grounding (touching conducting metal, water or heating pipes, etc.).

4.9 Equilibrium wood moisture content

If wood is stored in a particular climate for a long period, it takes up the moisture matching this climate, which is termed equilibrium moisture content or equilibrium wood moisture content.

On reaching the equilibrium moisture content, the wood no longer loses moisture if the surrounding conditions remain the same and also does not take up any moisture.

The equilibrium wood moisture content is between approx. 6.0 and 7.5 % wood moisture (corresponds to 30–40 % rel. humidity and 20-25 °C) in the winter months, and between approx. 10.5 and 13.0 % (corresponding to 60–70 % rel. humidity and 25 °C) in the summer months. Further values and tables can be found on the Internet.

4.10 Growth ranges of fungi

Dry rot	18 - 22° C,	20 - 28 % wood moisture
Wet rot	22 - 26° C,	> 55 % wood moisture
<i>Poria vaporaria</i>	25 - 28° C,	40 - 50 % wood moisture
<i>Gloeophyllum abietinum</i>		35 - 45 % wood moisture
<i>Lentinus</i>		40 - 60 % wood moisture
Blue stain fungi		> 25 % wood moisture

4.11 Swelling and shrinkage of the wood

Wood shrinks if it transfers moisture to the surrounding air below the fibre saturation level. On the other hand, wood swells if it takes up moisture from the surrounding air below the fibre saturation level. This is a very complex process. If you are interested, we recommend finding the relevant information on the Internet.

5 Appendix

5.1 Material table

0	Display in digits
2	Type of wood 2
3	Type of wood 3
11	Cement screed in wt.-%
12	Anhydrite screed in wt.-%
14	Cement mortar in wt.-%
15	Lime mortar in wt.-%
17	Gypsum plaster in wt.-%
18	Cement screed in CM-%
19	Lime sand brick in CM-%
21	Foamed polystyrene in wt.-%
50	Anhydrite screed in CM-%
51	Gas concrete (Hebel company) in wt.-%
52	Gypsum screed in wt.-%
53	Gypsum screed in CM-%
54	Gypsum plaster in CM-%
55	Lime mortar in CM-%
56	Pressed cork in wt.-%

57	Xyolite acc. to DIN, in wt.-%
58	Cement mortar in CM-%
59	Gas concrete (Ytong PPW4 type) in wt.-%
60	Bricks in wt.-%
65	Concrete, 350kg/m ³ , B25, in wt.-%
69	Natural cork in wt.-%
70	Wood cement screed in wt.-%
71	Glass mineral wool in wt.-%

5.2 Air humidity - material moisture comparison graphic

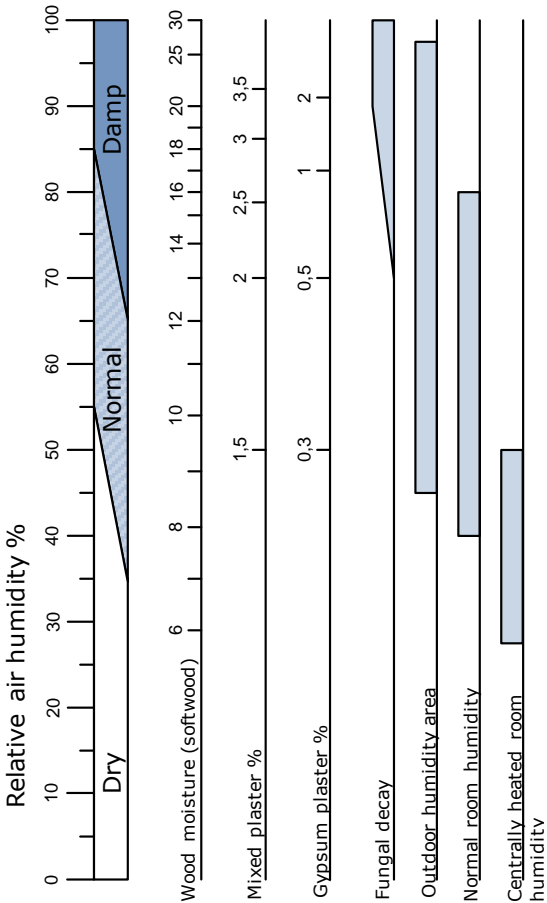

Notes on the graphic in section 5.2:

The areas shown in the graphic have the following meanings:

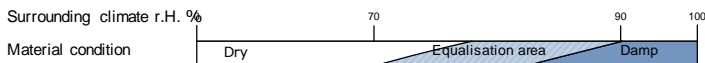

Light area: dry

Equilibrium moisture content reached.

Shaded area: equalisation area

Caution! Coatings or adhesives without diffusion properties should not yet be processed. Contact the respective manufacturer.

Dark area: damp

Handling and processing at very high risk!

Warning:

The notes and tables in these operating instructions on permitted or normal humidity conditions in practice and the general definitions of terms have been taken from the specialist literature. No responsibility can therefore be assumed by the manufacturer of the measuring instrument for the correctness of this information. The conclusions to be drawn from the measurement results are related to the individual conditions and the knowledge drawn from professional experience for each user.

6 Accessories



MK8 measuring cable – length: 1 m
(order no. 6210)



ET-100 stick-in temperature sensor
(order no. 13165)

Robust, stick-in temperature sensor for solid matter, bulk goods and liquids (-50 to +250 °C).



IR 40 BL infrared surface temperature sensor
(order no. 13150)

Electronic infrared surface temperature measuring instrument for non-contact measurement with additional laser pointer. An ideal device for detecting thermal bridges or determining dew point temperature undershoots. Particularly suited to the measurement of parts with low thermal capacity, e.g. wood, glass, insulation materials, etc. and for position determination of heating coils.



For your notes:



GANN MESS- U. REGELTECHNIK GMBH

70839 GERLINGEN SCHILLERSTRASSE 63

70826 GERLINGEN POSTFACH 10 0165

INTERNET: <http://www.gann.de>

TELEFON (07156) 49 07-0

TELEFAX (07156) 49 07-48

E-MAIL: sales@gann.de