

optris® CSLaser G5HF

Two-wire infrared thermometer for temperature measurement of glass from 200°C to 1450°C



FEATURES

- Accurate glass temperature measurements on flat glass lines, container glass machines, bulb manufacturing and car glass finishing
- Measuring spots up from 1,6 mm and response times up from 30 ms
- Standard two-wire interface for reliable data transfer and easy integration into a PLC
- Innovative double-laser sighting for exact marking of measurement targets
- Fast sensor parameterisation and real-time measurement via USB
- Dependable in ambient temperatures up to 85°C without additional cooling

General specifications

Environmental rating	IP 65 (NEMA-4) front mountable at vacuum processes (up to 10 ⁻³ mbar)
Ambient temperature	-20°C to 85°C (50°C with laser ON)
Storage temperature	-40°C to 85°C
Relative humidity	10 - 95%, non condensing
Vibration	IEC 68-2-6: 3 G, 11-200 Hz, any axis
Shock	IEC 68-2-27: 50 G, 11 ms, any axis
Weight	600 g

Electrical specifications

Output / analog	4 - 20 mA
Loop resistance	max. 1000 Ω ¹⁾
Output / alarm	0 - 30 V / 500 mA (open-collector)
Output/ digital	uni-/ bidirectional, 9,6 kBaud, 0/3 V Pegel, USB optional
Cable length (connector version only)	3 m / 8 m / 15 m
Current draw (laser)	45 mA at 5 V 20 mA at 12 V 12 mA at 24 V
Power supply	5 - 28 V DC

Measurement specifications

Temperature range (scalable via software)	200°C to 1450°C
Spectral range	5 µm
Optical resolution (90 % energy)	45:1
System accuracy (at T _{amb} = 23 ± 5°C)	± 1% or ± 1°C ²⁾
Repeatability (at T _{amb} = 23 ± 5°C)	± 0.5% or ± 0.5°C ²⁾
Temperature resolution	0.1 K
Response time (90% signal)	30 ms
Emissivity/ Gain (adjustable via sensor or software)	0.100 - 1.100
IR window correction (adjustable via software)	0.100 - 1.000
Signal processing (parameter adjustable via software)	peak hold, valley hold, average; extended hold function with threshold and hysteresis
Software	optris Compact Connect

¹⁾ in dependence on supply voltage

²⁾ whichever is greater

Optical parameter

Chart of SF optics, D:S = 45:1

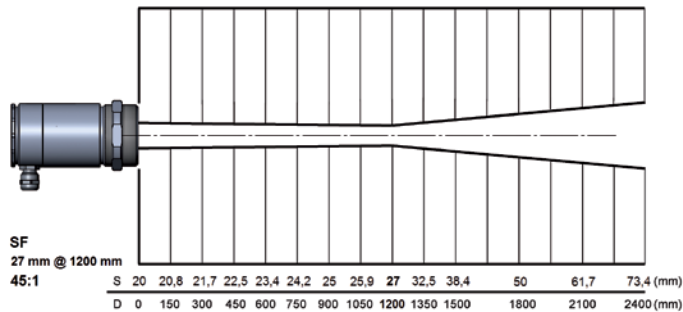

Further optics, D:S = 45:1

...SF	27.0 mm @ 1200 mm
...CF1	1.6 mm @ 70 mm
...CF2	3.4 mm @ 150 mm
...CF3	4.5 mm @ 200 mm
...CF4	10.0 mm @ 450 mm

Connections

Analog mode of operation

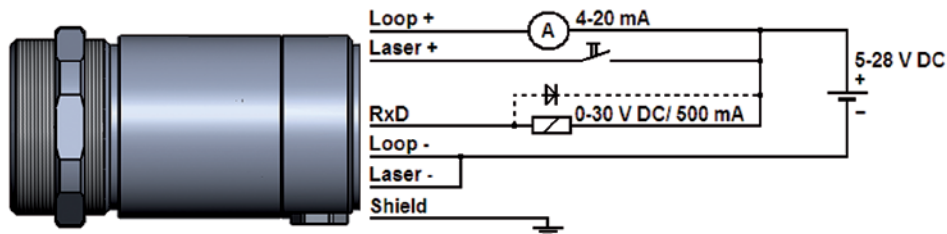

Digital mode of operation

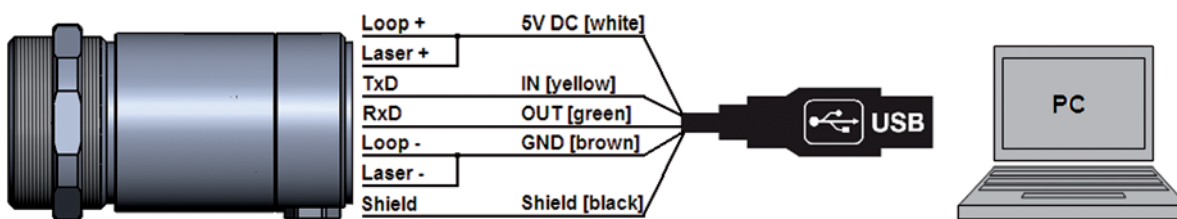

Dimensions

Dimensions CSLaser hs LT

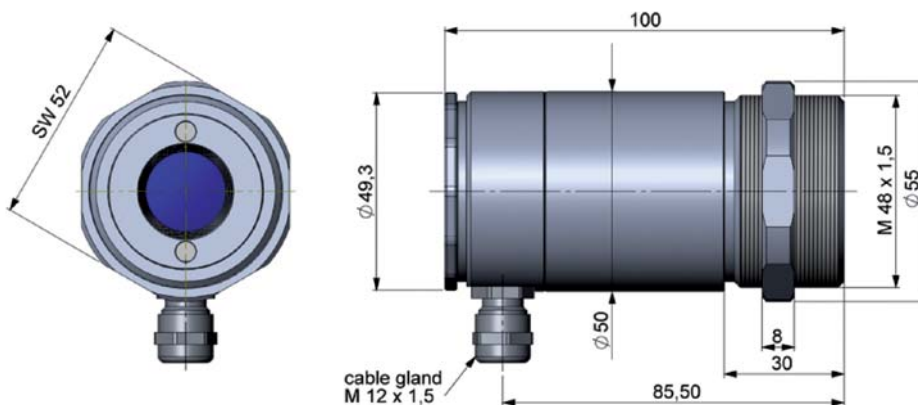

Electrical connections /
emissivity adjustment
(sensor back side)

