

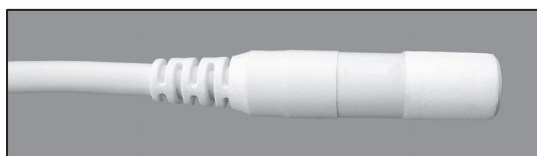

Temperature/RH Smart Sensor (S-THB-M00x)

The Temperature/RH smart sensor is designed to work with smart sensor-compatible HOBO® data loggers. All sensor parameters are stored inside the smart sensor, which automatically communicates configuration information to the logger without any programming, calibration or extensive user setup.



Specifications	Temperature	RH
Measurement Range	-40°C to 75°C (-40°F to 167°F)	0-100% RH at -40° to 75°C (-40° to 167°F); exposure to conditions below -20°C (-4°F) or above 95% RH may temporarily increase the maximum RH sensor error by an additional 1%
Accuracy	±0.21°C from 0° to 50°C (±0.38°F from 32° to 122°F); see Figure 1	±2.5% from 10% to 90% RH (typical), to a maximum of ±3.5% including hysteresis. See Figure 2 for full range.
Resolution	0.02°C at 25°C (0.04°F at 77°F); see Figure 1	0.1% RH at 25°C (77°F)
Bits Per Sample	12	10
Drift	< 0.1°C (0.18°F) per year	< 1% per year typical
Response Time	5 minutes in air moving 1 m/sec	5 minutes in air moving 1 m/sec with protective cap
Operating Temperature Range	-40°C to +75°C (-40°F to +167°F)	
Environmental Rating	Weatherproof: 0 to 100% RH intermittent condensing environments. For best results, the Temp/RH Smart Sensor should be mounted inside a protective enclosure, such as a solar radiation shield.	
Housing	PVC cable jacket with ASA styrene polymer RH sensor cap; modified hydrophobic polyethersulfone membrane	
Sensor Dimensions	10 x 35 mm (0.39 x 1.39 in)	
Weight	S-THB-M002 - 110 g (3.88 oz); S-THB-M008 - 180 g (6.35 oz)	
Number of Data Channels *	2	
Measurement Averaging Option	No	
Cable Lengths Available	2.5 m (8.2 ft); 8 m (26.2 ft)	
Length of Smart Sensor Network Cable *	0.5 m (1.6 ft); 6 m (19.6 ft)	
Part Numbers	S-THB-M002, S-THB-M008	
	The CE Marking identifies this product as complying with all relevant directives in the European Union (EU).	

* A single smart sensor-compatible HOBO logger can accommodate 15 data channels and up to 100 m (325 ft) of smart sensor cable (the digital communications portion of the sensor cables).

Temperature/RH Smart Sensor

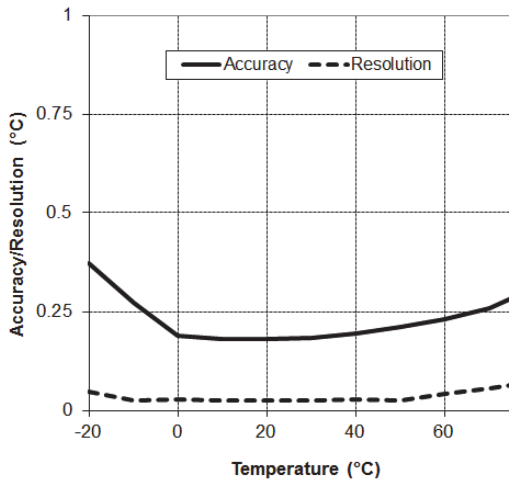

Figure 1: Temperature Accuracy and Resolution

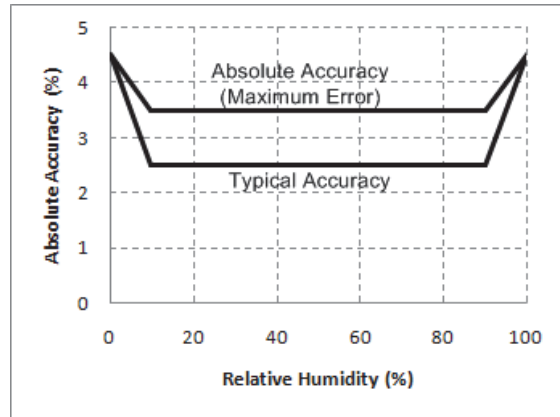

Figure 2: Relative Humidity Accuracy

Inside this Package

- Temp/RH Smart Sensor

Mounting

Accessories

Solar Radiation Shield (part # M-RSA or RS3)

Replacement RH Sensor (part # HUM-RHPCB-2)

Typical Mounting

- Solar Radiation Shield: Use the washer and screw (included with the M-RSA radiation shield) or cable clamps (included with the RS3 radiation shield) to secure the smart sensor in the radiation shield as shown in Figures 3 and 4.

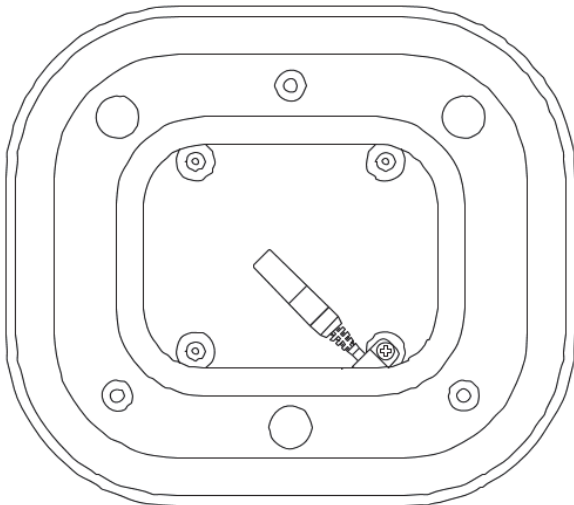

Figure 3: Temp/RH Sensor mounted in the Solar Radiation Shield M-RSA

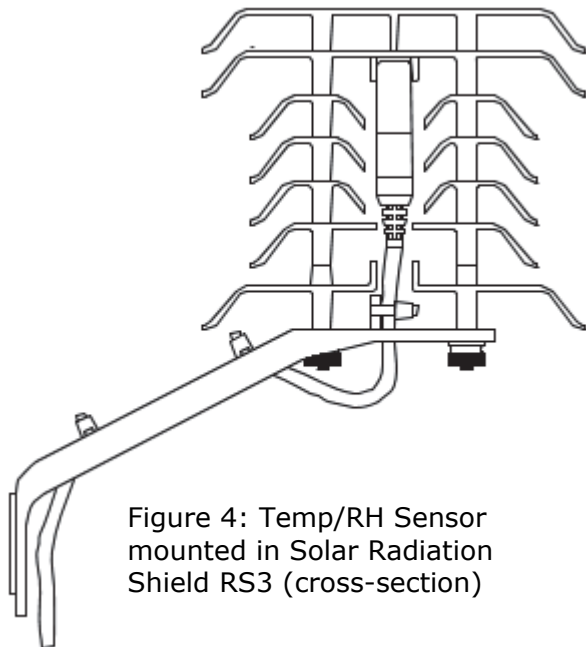
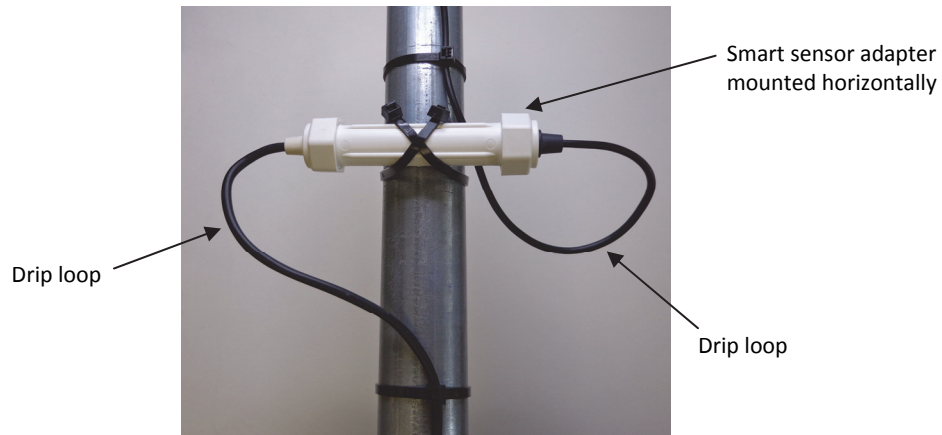

Figure 4: Temp/RH Sensor mounted in Solar Radiation Shield RS3 (cross-section)

Temperature/RH Smart Sensor

Mounting Considerations

- A solar radiation shield is strongly recommended when measuring air temperature in direct sunlight. Solar radiation can be a significant source of error in the temperature and RH readings.
- When mounting the probe, care should be taken to thermally isolate the sensor from the mounting surface to ensure accurate air temperature and humidity readings. The probe's temperature sensor is at the end of the cable, just below the cup.
- It is recommended that the probe be protected from direct exposure to the weather. This will prolong the sensors' accuracy.
- If you are running sensor cables along the ground, it is recommended that you use conduit to protect against animals, lawn mowers, exposure to chemicals, and so on.
- To provide long-term protection from moisture entry, the smart sensor adapter must be mounted horizontally and with the cable wires routed with drip loops so that water drains away from the cable entry point as shown in the example below. When mounted properly, the housing is weatherproof (but not waterproof).



- Refer to the logger user's guide for more information regarding setting up complete stations.

Connecting

To use the sensor with the smart sensor-compatible HOB0 logger, stop the logger and insert the modular jack into an available port. If a port is not available, use a 1-to-2 adapter (Onset Part # S-ADAPT). The next time you launch the logger, it will automatically detect the new sensor. Note that the logger supports a maximum of 15 data channels. Use the software to launch the logger and verify the sensor is functioning correctly. See the logger user's guide for more details about connecting HOB0 smart sensors to loggers.

Replacing the RH sensor

The RH sensor is protected by an ASA styrene polymer cap and a modified hydrophobic polyethersulfone fluid barrier membrane that allows vapor to penetrate while protecting the sensor from condensation. RH sensor performance may degrade over time. To replace the RH sensor, take the following steps:

1. Remove the tape fastening the sensor cap to the receptacle. Discard the tape.
2. Grasp the cap and membrane and pull firmly to remove them. Discard them.

Temperature/RH Smart Sensor

3. **Note the orientation of the small circuit board containing the RH sensor.** Pull it out and discard it in compliance with local disposal guidelines for circuit boards.

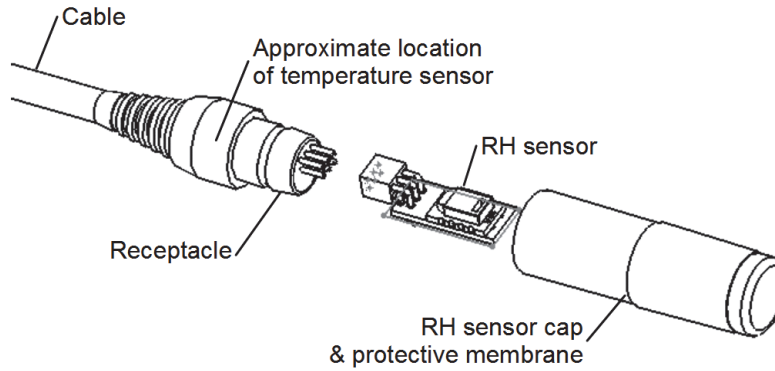

4. Push gently but firmly to install the new sensor (Onset part # HUM-RHPCB-2) **in the same orientation.**
5. Put the new sensor cap and membrane on. Do not force the cap. If it does not go on easily, the sensor may be installed backwards. Reverse the sensor and try again.

Maintenance

The Temperature/RH smart sensor is sensitive to dust, salts and other airborne contamination. Periodically inspect the RH sensor. If contamination is present on the protective cap, gently rinse it with cool fresh water. If the sensor itself is contaminated, you can rinse it with distilled water. Do not use hot water, organic solvents, or detergents. Dry before use.

© 2008–2013 Onset Computer Corporation. All rights reserved.
Onset and HOBO are registered trademarks of Onset Computer Corporation.