

Operating Instructions



HYDROMETTE BL COMPACT



EN



GANN MESS- U. REGELTECHNIK GMBH

70839 GERLINGEN

SCHILLERSTRASSE 63

INTERNET: <http://www.gann.de>

Verkauf National: TELEFON 07156-4907-0
Verkauf International TELEFON +49 7156-4907-0

TELEFAX 07156-4907-40
TELEFAX +49 7156-4907-48

EMAIL verkauf@gann.de
EMAIL sales@gann.de

Contents

0.1	Publication Declaration	4
0.2	WEEE Directive 2002/96/EC Electrics and Electronics Act	4
0.3	Safety Instructions	5
1	Introduction	8
1.1	Description.....	8
1.2	Instrument Design and Key Assignments	9
1.3	Display Icons	10
2	Basic Functions	11
2.1	Switching the Instrument On.....	11
2.2	Display in Measuring Mode	12
2.3	Settings Menus.....	12
2.3.1	Measuring Menu (main menu).....	13
2.3.2	Material Settings.....	14
2.3.3	Maximum Value.....	15
2.3.4	Minimum Value.....	18
2.4	Additional Functions	19
2.4.1	Automatic Shut-down	19
2.4.2	Battery Monitoring	19
2.4.3	Electrode Replacement	19

3	Specifications.....	20
3.1	Technical Specifications	20
3.2	Intolerable Ambient Conditions:.....	20
3.3	Measuring Range	21
4	Notes on Use	22
4.1	General Notes	22
4.2	Notes on Measuring Wood Moisture	22
4.2.1	Introduction.....	22
4.2.2	Static Electricity	24
4.2.3	Wood Moisture Equilibrium.....	24
4.2.4	Fungal Growth Ranges.....	25
4.2.5	Moisture Ranges for Coatings	25
4.2.6	Swelling and Shrinking of Wood.....	25
4.3	Notes on Building Moisture Measurements	26
4.3.1	Introduction.....	26
4.3.2	Equilibrium Moisture/Balance Moisture	27
4.3.3	Material not Covered by the Type Tables.....	27
5	Annex.....	28
5.1	Type Table.....	28
5.2	Wood Types Table	29
5.3	Comparison Graph of Humidity - Material Moisture Content	30

0.1 Publication Declaration

This publication replaces all previous versions. It may not be reproduced or electronically processed, duplicated or distributed in any way without the written permission of Gann Mess- u. Regeltechnik GmbH. Subject to technical and documentary change. All rights reserved. This document was compiled with the necessary care. Gann Mess- u. Regeltechnik GmbH accepts no liability whatsoever for errors or omissions.

GANN Mess- u. Regeltechnik GmbH, Gerlingen, 07 Nov. 2014

0.2 WEEE Directive 2002/96/EC Electrics and Electronics Act

The packaging, battery and instrument must be disposed of in a recycling centre in accordance with legal regulations.

The instrument was manufactured after 01.10.2009

0.3 Safety Instructions

This measuring instrument conforms to the 2004/108/EG) (EN61010) standard and fulfils the requirements of applicable European and national directives. Appropriate declarations and documentation are located with the manufacturer. The user must read these operating instructions in order to guarantee problem-free instrument operation and operational safety. The measuring instrument may only be operated under the specified climatic conditions. These conditions can be found in Section 3.1 "Specifications". In addition, this measuring instrument may only be operated under the conditions and for the purpose it was designed for. The operational safety and functionality are no longer guaranteed if the instrument is modified or converted. Gann Mess-u. Regeltechnik GmbH assumes no liability for any ensuing damage. All risks are assumed solely by the user.

- The instrument may not be stored or operated in aggressive atmospheres or atmospheres containing solvents!
- **Static electricity** - At low humidities static electricity charges with high voltages may build up, favoured by external influences (friction during material transport, high environmental isolation value), which may not only lead to strong fluctuations in the measured data or negative values, but also to the destruction of electrical components in the instrument. Even the instrument operator may - inadvertently - contribute to the build up of a static charge by the clothing worn. A considerable improvement can be achieved by the operator and the measuring instrument being absolutely still during measuring, as well as by earthing (contact with conducting metal, water or heating pipes, etc.).

- Frozen wood cannot be measured.
- The notes and tables on allowable or common moisture conditions in practice and general definitions given in these instructions were taken from the technical literature. The manufacturer therefore cannot accept any liability for correctness. The conclusions drawn from the measurement results depend on each user's individual requirements and practical, professional empiricism.
- Because the measuring instrument adheres to the stricter emitted interference (EMC) Class B it may be operated in residential and commercial environments.
- The measuring instrument and any accessories used may only be used for the purpose intended, as described in these instructions. The instrument and accessories should be kept away from children!
- Do not measure wood or other materials on conductive surfaces.

Gann Mess- u. Regeltechnik GmbH accepts no liability for damage caused by non-compliance with the operating instructions or by violation of a duty to care during transport, storage and handling of the instrument when operating, even if this duty to care is not specifically discussed in the operating instructions.



CAUTION: There is a danger of injury from the measuring pins if the measuring instrument is carried without the protective cover or other protective packaging. There is also a danger of injury due to careless handling of the measuring pins during the measuring procedure. Before pressing the electrode pins into walls or ceilings, ensure that no electrical cables, water pipes or other utilities are present using suitable means.

1 Introduction

1.1 Description

The Hydromette BL Compact is an electronic moisture meter for various types of wood and soft building and insulating materials with a 3-line LCD display. The measuring pins are pressed into the respective medium and allow recording of the moisture content of sawn timber, chipboard, veneers and wood fibre materials up to a maximum of 25 mm thick, as well as insulating materials or normal gypsum and mixed plasters.

1.2 Instrument Design and Key Assignments



1.3 Display Icons

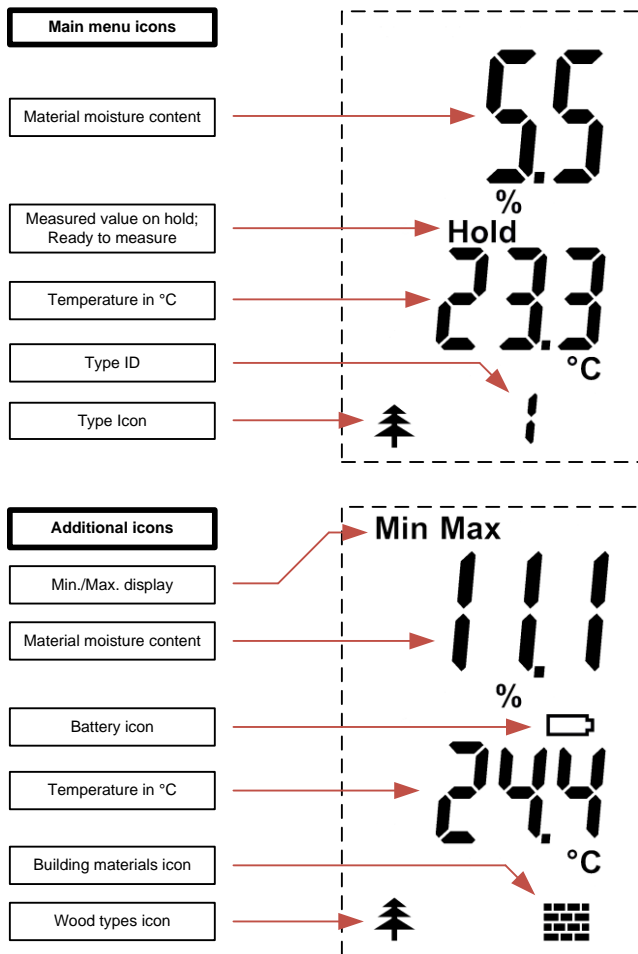

2 Basic Functions

2.1 Switching the Instrument On

The instrument is switched on by pressing the "On" key .

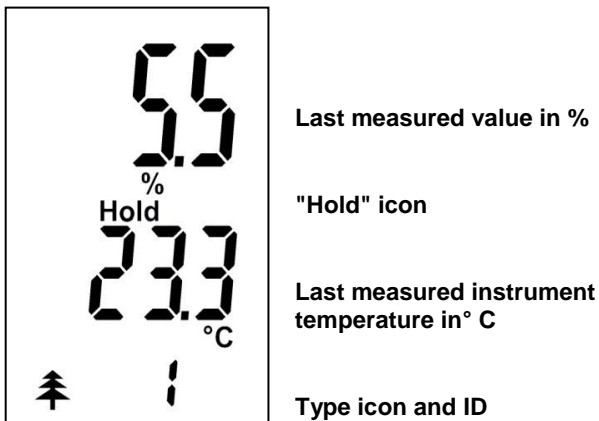

Figure 2-1 Main menu

A new measurement can be started in this menu by pressing measuring key "M". Also see Section 2.2 "Measuring mode".

2.2 Display in Measuring Mode

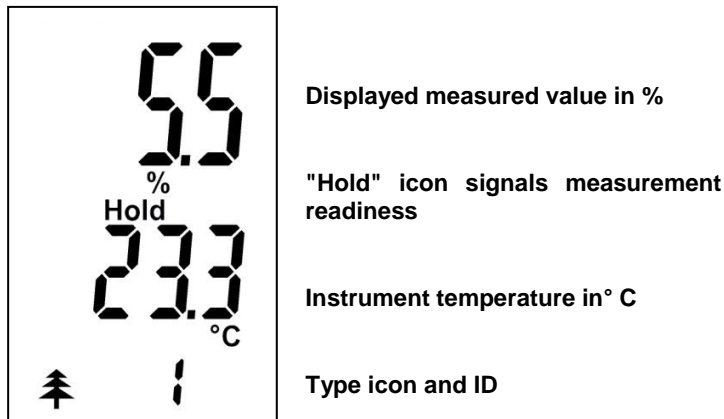

Figure 2-2 Measuring mode

A measuring process is started by pressing the "M" key.

2.3 Settings Menus

By repeatedly pressing the "Up" and "Down" keys the following menu can be selected in sequence (sequence using the "Down" key; the menus are accessed in the opposite direction using the "Up" key):

1. **Measuring menu** (main menu): The measuring process can be performed from here.
2. **Type selection**: The material type can be selected here.
3. **Maximum value**: The largest measured value is displayed
4. **Minimum value**: The smallest measured value is displayed.

2.3.1 Measuring Menu (main menu)

The last measured value is shown together with the comment "**Hold**". The instrument temperature and the current type are also shown on the display.

A new measurement can be started in this menu by pressing the "**M**" key.

The "**Hold**" icon disappears from the display during the measurement and the % sign flashes. If the measured value remains stable the % sign stays on and the measured value is stored after releasing the "**M**" key. The "**Hold**" icon is displayed again.

If the new measured value is greater or smaller than the previous maximum or minimum, "**Max**" or "**Min**" flash on the display. The "**M**" key is pressed briefly to store the new value as the new minimum or maximum. A new measurement can be started without altering the previous minimum or maximum by pressing "**M**" longer if the value is not to be stored.

If a measurement is outside of the measuring range ($< 6\%$, $> 25\%$) a flashing value, which is additionally marked by "**LO**" or "**HI**", warns of this.

2.3.2 Material Settings



The specified material ID is displayed with the icon for wood moisture or material moisture.

Material icon and ID

Figure 2-3 Material selection

To change the preset for the type, the device must be switched on and be situated in the main measurement mode (mode immediately after switching on the device). After pressing the **"Down"** key the device displays the view as shown in Figure 2-3.

If now the default for the type should be changed press the **"M"** key (measure key) *briefly* to change the preset for the type.

The type ID flashes and can be set using the **"Up"** and **"Down"** keys. Press the **"M"** key again *briefly* to save the change.

The type table can be found in the Annex.

Maximum Value

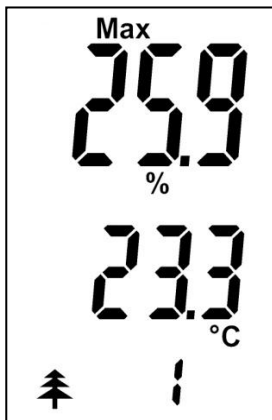

The largest measured moisture value of a series is displayed together with the display icon "Max."

Type icon and ID

Figure 2-4 Maximum value

To delete a maximum value the displayed value must be selected by briefly pressing the "M" key (measure key):

The value and the % sign are now flashing and the value can be deleted by pressing the "M" key *longer*. Once the value has been deleted only the % sign flashes. By *briefly* pressing the "M" key once again the deletion is confirmed and the % sign disappears. The instrument returns to the ready mode.

A new measurement can then be carried out using the "M" key.

Graphic Quick Guide

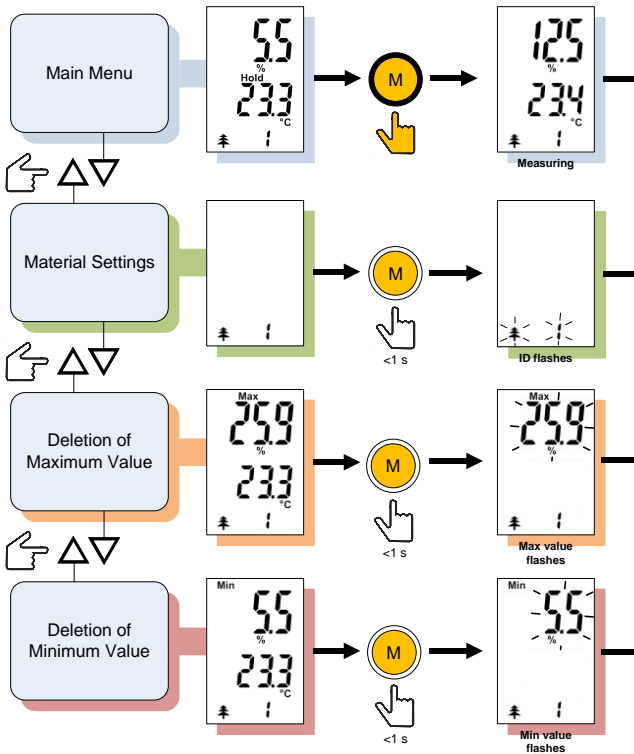

legend



On / Off key – Device shuts down after 30 seconds if no key is pressed during that time



Press measure key



Press measure key longer than 2 seconds



Press measure key briefly

Graphic Quick Guide

 Mess- u. Regeltechnik
GmbH

Software Version:

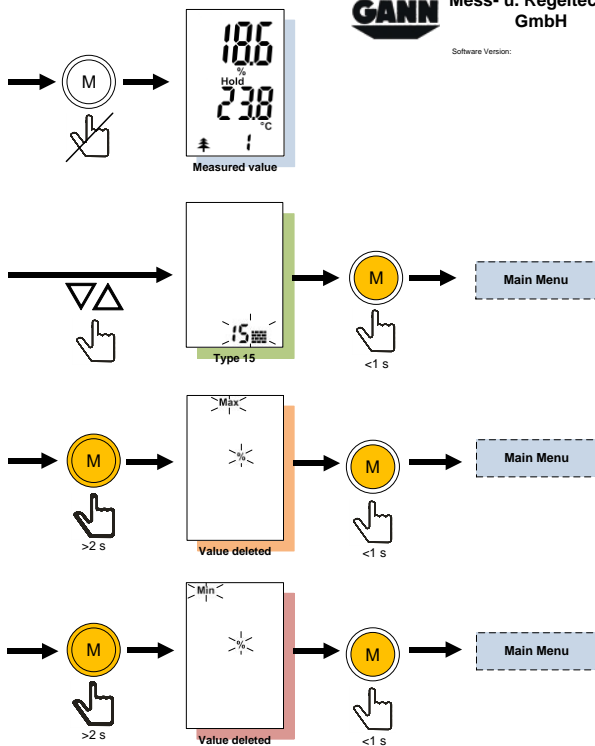

legend



Release measure key

 „up“ or „down“ for menu
selection

Press „up“ or „down“ key

2.3.3 Minimum Value

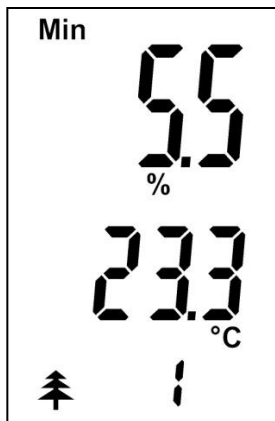

The smallest measured moisture value of a series is displayed together with the display icon "Min"

Type icon and ID

Figure 2-5 Minimum value

To delete a minimum value the displayed value must be selected by *briefly* pressing the "M" key (measure key):

The value and the % sign are now flashing and the value can be deleted by pressing the "M" key *longer*. Once the value has been deleted only the % sign flashes. By *briefly* pressing the "M" key once again the deletion is confirmed and the % sign disappears. The instrument returns to the ready mode.

A new measurement can then be carried out using the "M" key.

2.4 Additional Functions

2.4.1 Automatic Shut-down

If no key is pressed for approx. 30 seconds the instrument switches off automatically. The current data are retained and are displayed again after switching on.

2.4.2 Battery Monitoring

If the battery icon  appears in the display the battery is empty and must be replaced.

A list of suitable battery types can be found in the "Specifications" section.

2.4.3 Electrode Replacement

The knurled screws must be loosened to replace the electrodes. The pins can then be easily replaced.

Care must be taken that the knurled screws are always sufficiently tightened to prevent measuring errors and the area between the pins is kept clean.

3 Specifications

3.1 Technical Specifications

Display:	3-line display
Display resolution:	0.1%
Reaction time:	< 2 s
Storage conditions:	+ 5 to + 40° C - 10 to + 60° C (short-term)
Operating conditions:	0 to + 50° C - 10 to + 60° C (short-term)
Power supply:	9 V battery
Usable types:	Type 6LR61 or Type 6F22
Dimensions:	200 x 50 x 30 (L x B x H) mm
Weight:	approx. 170 g

3.2 Intolerable Ambient Conditions:

- Condensation, continuously high humidity (> 85%) and wet
- Continuous dust exposure and flammable gases, vapours or solvents
- Continuously high ambient temperatures (> + 40° C)
- Continuously low ambient temperatures (< + 5° C)

3.3 Measuring Range

Wood moisture: 6 to 25% (depending on type)

4-stage wood type correction

Building moisture: 0.4 to 6.0% wt. (depending on material)

Building materials: Lime mortar, gypsum plaster, mixed plasters

Insulating materials: Styrofoam, wood fibre insulation panels

4 Notes on Use

4.1 General Notes

Wood moisture measurement using the Hydromette BL Compact is by means of resistance measurement. This allows direct display of moisture content in percent by weight. The display range is between 6% and 25% with a 4-stage wood type correction.

Measurement of building and material moisture is also by means of resistance measurement. The display range is between 0.4% and 6.0% weight, depending on the respective material.

4.2 Notes on Measuring Wood Moisture

4.2.1 Introduction

The Hydromette BL Compact works by the well-known principle of electrical resistance or conductivity measurement. This method is based on the fact that electrical resistance is closely related to the respective wood moisture content. The conductivity of oven-dried wood is very low and the resistance so great that practically no current can flow. The more water present, the more conductive is the wood and the lower the electrical resistance.

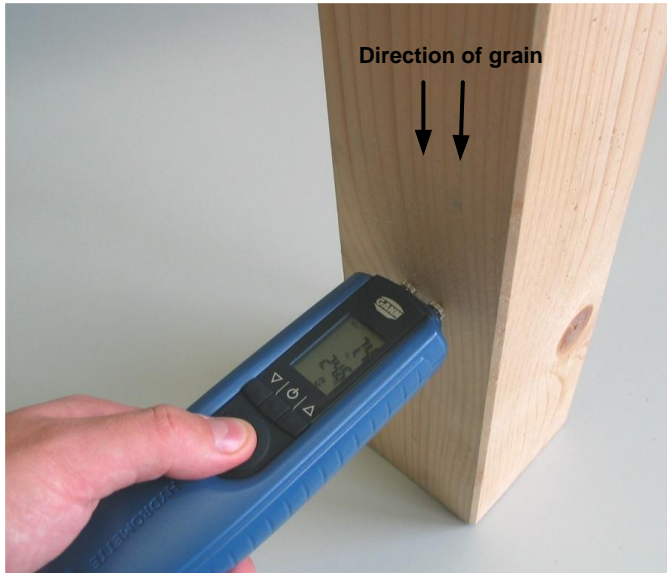

Figure 4-1 Measuring perpendicular to the grain

In order to achieve high-quality measurement results the selected wood samples should be measured at several points. The electrode pins must be pressed into the wood across the grain to at least 1/4 of the total wood thickness, but 1/3 maximum. Care must be taken that the knurled screws are always sufficiently tightened to prevent measuring errors and the area between the tip slots is kept clean.

It is not possible to measure frozen wood.

4.2.2 Static Electricity

At low humidities static electricity charges with high voltages may build up, favoured by external influences (friction during material transport, high ambient isolation value), which may not only lead to strong fluctuations in the measured data or negative values, but also to the destruction of electronic components in the instrument. Even the instrument operator may - inadvertently - contribute to the build up of a static charge by the clothing worn. A considerable improvement can be achieved by the operator and the measuring instrument being kept absolutely still during measuring, as well as by earthing (contact with conducting metal, water or heating pipes, etc.).

4.2.3 Wood Moisture Equilibrium

If wood is stored for extended periods in a given climate it assumes a moisture content corresponding to this climate, which is also termed equilibrium moisture or wood moisture equilibrium.

When the equilibrium moisture is reached the wood does not give off or absorb any further moisture for constant ambient climatic conditions.

The wood moisture equilibrium in the winter months is approx. 6.0% to 7.5% wood moisture (corresponds to 30–40% rel. humidity and 20–25° C) and in the summer months approx. 10.5% to 13.0% (corresponds to 60–70% rel. humidity and 25° C). Additional data and tables can be found on the internet.

4.2.4 Fungal Growth Ranges

Dry rot	18 - 22° C,	20 - 28% wood moisture
Cellar fungus	22 - 26° C,	> 55% wood moisture
White fungus	25 - 28° C,	40 - 50% wood moisture
Bracket fungi fungus		35 - 45% wood moisture
Scaly lentinus		40 - 60% wood moisture
Blue stain		> 25% wood moisture

4.2.5 Moisture Ranges for Coatings

The range of applications of modern paints, varnishes, glazes, etc. is so large that no general rules can be given.

Recommendation: Ask the respective coating manufacturer for information before use.

4.2.6 Swelling and Shrinking of Wood

Wood shrinks when it gives off moisture to the surrounding air below the fibre saturation range. In contrast, wood swells when it absorbs moisture from the surrounding air below the fibre saturation range. This is a very complex process. If you are interested in this topic we recommended searching for suitable information sources on the internet.

4.3 Notes on Building Moisture Measurements

4.3.1 Introduction

The Hydromette BL Compact works by the well-known principle of electrical resistance or conductivity measurement. This method is based on the fact that electrical resistance is closely related to the respective material moisture content. The conductivity of oven-dried material is very low and the resistance so great that practically no current can flow. The more water present, the more conductive is the material and the lower the electrical resistance.

In order to achieve high-quality measurement results the material should be measured at several points. The electrode pins must be pressed well home. Both electrode pins should generally only be pressed into the same piece of material.

It is not possible to measure material that is frozen or has a wet surface.

When originally delivered the instrument includes 10 x 20 mm long electrode pins. They are suitable for measuring to depths of up to 15 mm maximum.

Care must be taken that the knurled screws are always sufficiently tightened to prevent measuring errors and the area between the pins is kept clean.

Caution:

We do not recommend pressing the electrode pins into hard building materials (screed, concrete, etc.), as this may produce considerable measurement differences (a value that is too low/dry is displayed). The electrode tip contact to the material is problematic here.

4.3.2 Equilibrium Moisture/Balance Moisture

The equilibrium values generally given in practice are relative to an average mid-European climate of 20° C and 65% rel. humidity. These data are often also known as "balance moisture" or as "air dry". However, they should not be confused with values representing material processing or machining ability.

Floor/wall coverings and coating must be considered and evaluated in conjunction with the respective diffusion characteristics of the materials used. Please observe the recommendations made by the respective paint or covering manufacturer.

The long-term ambient climate must also be taken into consideration for the assessment of wall surfaces. The lime mortar plaster in an old vaulted cellar can easily have a moisture content of 2.6 percent by weight, a gypsum plaster in a centrally heated room should be classified as too moist, on the other hand, at 1.0 percent by weight moisture content.

We recommend an internet search for acquiring more detailed information.

4.3.3 Material not Covered by the Type Tables

Diverse building materials, such as bricks, sand-lime bricks, etc., cannot be measured with the usual accuracy due to their varying mineral additives or firing duration. However, this does not mean that comparative measurements in the same building material and on the same object are not meaningful.

For example, different levels of displayed values may help to localise the extent of a moisture field (water damage) or drying-out progress be identified by comparative measurements on dry internal and wet external walls.

Insulating materials such as rock wool/glass wool, synthetic foams, etc., cannot be measured exactly in a dry condition due to their

high insulation capabilities. Measured values are generally simulated by (continuous values) internal static. Moist to wet insulating materials are displayed and relatively well recognisable. However, conversions between percentages by weight or volume are not possible.

5 Annex

5.1 Type Table

1	Wood type 1	15	Lime mortar
2	Wood type 2	16	Mixed plaster
3	Wood type 3	17	Gypsum plaster
4	Wood type 4	21	Styrofoam
5	Natural cork	22	Wood fibre insulating panels

5.2 Wood Types Table

Wood type	ID	Wood type	ID
Obeche	2	Lime	2
Dibetou	4	Mahogany, true	3
Maple	3	Makore	3
Balsa	3	Meranti	3
Birch	3	Walnut	3
Pear tree	2	Okoume, Gabon	2
Bubinga	4	Palisander	2
Beech, white, red	2	Poplar	3
Douglas fir	3	Ramin	2
Yew	3	Rubberwood	1
Oak	3	Sapelli	3
Oak red, white	2	Sitka spruce	3
Alder	3	Sipo	4
Ash	3	Fir	3
Spruce	3	Tchitola	1
Pine	3	Teak	2
Chestnut, Spanish, Horse	3	Elm	3
Cherry	3	Weymouth pine	3
Larch	3	Zebrano	1
Limba	3	Stone pine	3

5.3 Comparison Graph of Humidity - Material Moisture Content

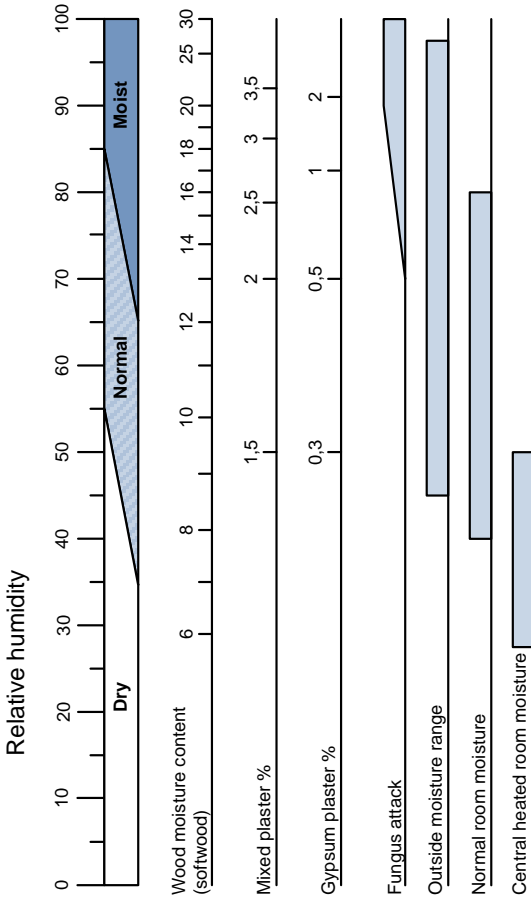

Notes on graph in Section 5.3:

The zones shown in the graph indicate:

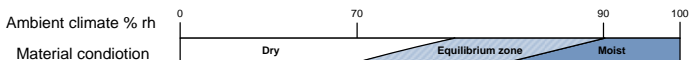

Pale zone: dry

Equilibrium moisture.

Hatched zone: equilibrium zone

Caution! Non-diffusing coverings or adhesives should not be used.
Please ask the respective manufacturer.

Dark zone: moist

Machining or processing at very high risk!