

Description of the Sensor

PM-V sensors with **integrated hx-processor** measure humidity by means of a humidity-dependant condenser. The capacitive Mela® humidity measuring element, produced using thinfilm technology, consists of a base plate, on which the electrodes are housed and a hygroscopic polymer layer above it. The hygroscopic polymer layer absorbs water molecules from the medium to be measured (air) or releases them, thereby altering the capacity of the condenser.

The humidity or temperature values measured are calculated in the exchangeable PMU-V measuring head, with the calibration values stored there, and communicated on to the following electronic transmitter components as calibrated digital measuring values.

The PMU-V measuring heads are calibrated and thus enable an easy replacement. Replaced measuring heads can be recalibrated in the factory.

The transmitter with the hx processor uses the values of the relative humidity and the temperature to calculate the dew point temperature, the enthalpy, the water content, the absolute humidity or the wet-bulb temperature, in accordance with the laws of physics. The values are emitted at two analogue outputs with the standardised signals 0...10VDC, 0...1VDC, 0...20mA or (0) 4...20mA. The outputs can be configured differently and are defined using the software. Further measuring ranges on request.

The Mela® measuring element is protected by a filter and a basket guard. The sensors are designed for unpressurised systems, the measurement medium is non-aggressive air.

Please consult the "application instructions for the sensing elements" (product info sheet no. A 1) or check with the manufacturer for further information which you need to bear in mind when using humidity sensors with capacitive sensing elements.

¹⁾ Ex works. Depending on the specific range of application a regular recalibration of the sensor head (PMU-V) has to be effected.

²⁾ Higher accuracies on request.

³⁾ The accuracy of the calculated values depends on both the operating point in accordance with the hx diagram and on the primary values measured.

⁴⁾ See load diagram

Sensor for Humidity and Temperature with hx Processor PM-V

with calibrated and exchangeable measuring head for direct output of various physical values

Digital Measuring Head PMU-V

Humidity

measuring range	0...100%rh
measuring accuracy 10...90%rh at 23°C	±1.5%rh ¹⁾²⁾
at <10%rh or >90%rh	±2%rh
at <10°C or >40°C	±0.05%rh/K additional
resolution	0.01%rh (read out)
hysteresis	< 1%rh

Temperature

measuring element	Pt1000 1/3DIN
measuring range	-40...+85°C
measuring accuracy	±0.15 K at 23°C
resolution	0.01K (read out)
influence of temperature (TK)	<0.005 K/K

Transmitter PMO...V with hx Processor

physical outputs

dew point temperature	0...70°C ³⁾
enthalpy	0...80 kJ/kg ³⁾
water content.....	0...100g/kg dry air ³⁾
absolute humidity	0...20g/m ³ or 0...100g/m ³ ³⁾
wet-bulb temperature	-10...+50°C ³⁾
relative humidity	0...100%rh
temperature ranges	-30...+70°C; 0...+50°C; 0...100°C

There are respectively 2 physical values available at the output

response time t ₆₃ at v=2m/s	< 15 s
---	--------

electrical outputs	
voltage	2x 0...1VDC, or 2x 0...10VDC
current (PM80V and PM100V)	2x 0(4)...20mA
linearity	<0.25%

power supply:

PM80V + PM100V: 0 ... 1V:	6 ... 30V DC / 24V AC ±10%
0 ... 10V:	15 ... 30V DC / 24V AC ±10%
0(4) ... 20mA:	15 ... 30VDC ⁴⁾
PM15V: 0 ... 1V:	6 ... 30VDC
0 ... 10V:	15 ... 30VDC

electromagnetic compatibility	ref. EN61326-1
min. load resistance for voltage output	10 kOhm
consumption of electronics	<10 mA
load for current output	acc. diagram
permissible ambient temperature	

at the sensor tube	-40...+85°C
at the housing (PM80V)	-40...+85°C
(PM100V)	-10...+60°C

max. air speed	15m/s
minimum air speed across the measuring head	

for output: 2 x 0(4)...20mA	1,5 m/s
2 x 0...1V, 2 x 0...10V	1 m/s

housing PMO100V	ABS light grey
PMO80V	aluminium die-casting, varnished
PMO15V	stainless steel

protective system housing PM15V, PM80V	IP65
protective system housing PM100V	IP64

probe material	stainless steel
mounting position	optional

contacting	connecting terminals 1.5mm ² in the housing
PM15V length of connection cable	1.5m

Type Survey

Type	Order No.	Physical output 1	Measuring value 1	Electrical output 1	Physical output 2	Measuring value 2	Electrical output 2
PMU-V "plug-and-measure unit"	630101023594	relative humidity	0...100%rh	ASCII (digital)	temperature	-30...+70°C (-40...+85°C)	ASCII (digital)
PM80V duct version alu housing 0...20mA	740101023261	relative humidity	0...100%rh	0...20mA	temperature	-30...+70°C	0...20mA
	740101023161	relative humidity	0...100%rh	0...20mA	temperature	0...100°C	0...20mA
	740101023061	relative humidity	0...100%rh	0...20mA	temperature	0...+50°C	0...20mA
	740305023261	dew point temperature	0...70°C	0...20mA	temperature	-30...+70°C	0...20mA
	740410023261	enthalpy	0...80kJ/kg	0...20mA	temperature	-30...+70°C	0...20mA
	740515023261	water content	0...100g/kg dry air	0...20mA	temperature	-30...+70°C	0...20mA
	740621023261	absolute humidity	0...100g/m ³	0...20mA	temperature	-30...+70°C	0...20mA
	740620023261	absolute humidity	0...20g/m ³	0...20mA	temperature	-30...+70°C	0...20mA
	740833023261	wet-bulb temperature	-10...+50°C	0...20mA	temperature	-30...+70°C	0...20mA
PM80V duct version alu housing 4...20mA	740101023271	relative humidity	0...100%rh	4...20mA	temperature	-30...+70°C	4...20mA
	740101023171	relative humidity	0...100%rh	4...20mA	temperature	0...100°C	4...20mA
	740101023071	relative humidity	0...100%rh	4...20mA	temperature	0...+50°C	4...20mA
	740305023271	dew point temperature	0...70°C	4...20mA	temperature	-30...+70°C	4...20mA
	740410023271	enthalpy	0...80kJ/kg	4...20mA	temperature	-30...+70°C	4...20mA
	740515023271	water content	0...100g/kg dry air	4...20mA	temperature	-30...+70°C	4...20mA
	740621023271	absolute humidity	0...100g/m ³	4...20mA	temperature	-30...+70°C	4...20mA
	740620023271	absolute humidity	0...20g/m ³	4...20mA	temperature	-30...+70°C	4...20mA
	740833023271	wet-bulb temperature	-10...+50°C	4...20mA	temperature	-30...+70°C	4...20mA
PM100V duct version ABS housing 0...20mA	750101023261	relative humidity	0...100%rh	0...20mA	temperature	-30...+70°C	0...20mA
	750101023161	relative humidity	0...100%rh	0...20mA	temperature	0...100°C	0...20mA
	750101023061	relative humidity	0...100%rh	0...20mA	temperature	0...+50°C	0...20mA
	750305023261	dew point temperature	0...70°C	0...20mA	temperature	-30...+70°C	0...20mA
	750410023261	enthalpy	0...80kJ/kg	0...20mA	temperature	-30...+70°C	0...20mA
	750515023261	water content	0...100g/kg dry air	0...20mA	temperature	-30...+70°C	0...20mA
	750621023261	absolute humidity	0...100g/m ³	0...20mA	temperature	-30...+70°C	0...20mA
	750620023261	absolute humidity	0...20g/m ³	0...20mA	temperature	-30...+70°C	0...20mA
	750833023261	wet-bulb temperature	-10...+50°C	0...20mA	temperature	-30...+70°C	0...20mA
PM100V duct version ABS housing 4...20mA	750101023271	relative humidity	0...100%rh	4...20mA	temperature	-30...+70°C	4...20mA
	750101023171	relative humidity	0...100%rh	4...20mA	temperature	0...100°C	4...20mA
	750101023071	relative humidity	0...100%rh	4...20mA	temperature	0...+50°C	4...20mA
	750305023271	dew point temperature	0...70°C	4...20mA	temperature	-30...+70°C	4...20mA
	750410023271	enthalpy	0...80kJ/kg	4...20mA	temperature	-30...+70°C	4...20mA
	750515023271	water content	0...100g/kg dry air	4...20mA	temperature	-30...+70°C	4...20mA
	750621023271	absolute humidity	0...100g/m ³	4...20mA	temperature	-30...+70°C	4...20mA
	750620023271	absolute humidity	0...20g/m ³	4...20mA	temperature	-30...+70°C	4...20mA
	750833023271	wet-bulb temperature	-10...+50°C	4...20mA	temperature	-30...+70°C	4...20mA

Type	Order No.	Physical output 1	Measuring value 1	Electrical output 1	Physical output 2	Measuring value 2	Electrical output 2
PM80V duct version alu housing	740101023211	relative humidity	0...100%rh	0...10VDC	temperature	-30...+70°C	0...10VDC
	740101023111	relative humidity	0...100%rh	0...10VDC	temperature	0...100°C	0...10VDC
0...10VDC	740101023011	relative humidity	0...100%rh	0...10VDC	temperature	0...+50°C	0...10VDC
	740305023211	dew point temperature	0...70°C	0...10VDC	temperature	-30...+70°C	0...10VDC
	740410023211	enthalpy	0...80kJ/kg	0...10VDC	temperature	-30...+70°C	0...10VDC
	740515023211	water content	0...100g/kg dry air	0...10VDC	temperature	-30...+70°C	0...10VDC
	740621023211	absolute humidity	0...100g/m ³	0...10VDC	temperature	-30...+70°C	0...10VDC
	740620023211	absolute humidity	0...20g/m ³	0...10VDC	temperature	-30...+70°C	0...10VDC
	740833023211	wet-bulb temperature	-10...+50°C	0...10VDC	temperature	-30...+70°C	0...10VDC
	PM80V duct version alu housing	740101023221	relative humidity	0...100%rh	0...1VDC	temperature	-30...+70°C
740101023121	relative humidity	0...100%rh	0...1VDC	temperature	0...100°C	0...1VDC	
0...1VDC	740101023021	relative humidity	0...100%rh	0...1VDC	temperature	0...+50°C	0...1VDC
	740305023221	dew point temperature	0...70°C	0...1VDC	temperature	-30...+70°C	0...1VDC
	740410023221	enthalpy	0...80kJ/kg	0...1VDC	temperature	-30...+70°C	0...1VDC
	740515023221	water content	0...100g/kg dry air	0...1VDC	temperature	-30...+70°C	0...1VDC
	740621023221	absolute humidity	0...100g/m ³	0...1VDC	temperature	-30...+70°C	0...1VDC
	740620023221	absolute humidity	0...20g/m ³	0...1VDC	temperature	-30...+70°C	0...1VDC
	740833023221	wet-bulb temperature	-10...+50°C	0...1VDC	temperature	-30...+70°C	0...1VDC
PM100V duct version ABS housing	750101023211	relative humidity	0...100%rh	0...10VDC	temperature	-30...+70°C	0...10VDC
	750101023111	relative humidity	0...100%rh	0...10VDC	temperature	0...100°C	0...10VDC
0...10VDC	750101023011	relative humidity	0...100%rh	0...10VDC	temperature	0...+50°C	0...10VDC
	750305023211	dew point temperature	0...70°C	0...10VDC	temperature	-30...+70°C	0...10VDC
	750410023211	enthalpy	0...80kJ/kg	0...10VDC	temperature	-30...+70°C	0...10VDC
	750515023211	water content	0...100g/kg dry air	0...10VDC	temperature	-30...+70°C	0...10VDC
	750621023211	absolute humidity	0...100g/m ³	0...10VDC	temperature	-30...+70°C	0...10VDC
	750620023211	absolute humidity	0...20g/m ³	0...10VDC	temperature	-30...+70°C	0...10VDC
	750833023211	wet-bulb temperature	-10...+50°C	0...10VDC	temperature	-30...+70°C	0...10VDC
	PM100V duct version ABS housing	750101023221	relative humidity	0...100%rh	0...1VDC	temperature	-30...+70°C
750101023121	relative humidity	0...100%rh	0...1VDC	temperature	0...100°C	0...1VDC	
0...1VDC	750101023021	relative humidity	0...100%rh	0...1VDC	temperature	0...+50°C	0...1VDC
	750305023221	dew point temperature	0...70°C	0...1VDC	temperature	-30...+70°C	0...1VDC
	750410023221	enthalpy	0...80kJ/kg	0...1VDC	temperature	-30...+70°C	0...1VDC
	750515023221	water content	0...100g/kg dry air	0...1VDC	temperature	-30...+70°C	0...1VDC
	750621023221	absolute humidity	0...100g/m ³	0...1VDC	temperature	-30...+70°C	0...1VDC
	750620023221	absolute humidity	0...20g/m ³	0...1VDC	temperature	-30...+70°C	0...1VDC
	750833023221	wet-bulb temperature	-10...+50°C	0...1VDC	temperature	-30...+70°C	0...1VDC

Type	Order No. (PM-key)	Physical output 1	Measuring value 1	Electrical output 1	Physical output 2	Measuring value 2	Electrical output 2
PMU-V "plug-and-measure unit"	630101023594	relative humidity	0...100%rh	ASCII (digital)	temperature	-30...70°C (-40...85°C)	ASCII (digital)
PM15V cable version 0...10VDC	730101023211	relative humidity	0...100%rh	0...10VDC	temperature	-30...+70°C	0...10VDC
	730101023111	relative humidity	0...100%rh	0...10VDC	temperature	0...100°C	0...10VDC
	730101023011	relative humidity	0...100%rh	0...10VDC	temperature	0...+50°C	0...10VDC
	730305023211	dew point temperature	0...70°C	0...10VDC	temperature	-30...+70°C	0...10VDC
	730410023211	enthalpy	0...80kJ/kg	0...10VDC	temperature	-30...+70°C	0...10VDC
	730515023211	water content	0...100g/kg dry air	0...10VDC	temperature	-30...+70°C	0...10VDC
	730621023211	absolute humidity	0...100g/m³	0...10VDC	temperature	-30...+70°C	0...10VDC
	730620023211	absolute humidity	0...20g/m³	0...10VDC	temperature	-30...+70°C	0...10VDC
	730833023211	wet-bulb temperature	-10...+50°C	0...10VDC	temperature	-30...+70°C	0...10VDC
PM15V cable version 0...1VDC	730101023221	relative humidity	0...100%rh	0...1VDC	temperature	-30...+70°C	0...1VDC
	730101023121	relative humidity	0...100%rh	0...1VDC	temperature	0...100°C	0...1VDC
	730101023021	relative humidity	0...100%rh	0...1VDC	temperature	0...+50°C	0...1VDC
	730305023221	dew point temperature	0...70°C	0...1VDC	temperature	-30...+70°C	0...1VDC
	730410023221	enthalpy	0...80kJ/kg	0...1VDC	temperature	-30...+70°C	0...1VDC
	730515023221	water content	0...100g/kg dry air	0...1VDC	temperature	-30...+70°C	0...1VDC
	730621023221	absolute humidity	0...100g/m³	0...1VDC	temperature	-30...+70°C	0...1VDC
	730620023221	absolute humidity	0...20g/m³	0...1VDC	temperature	-30...+70°C	0...1VDC
	730833023221	wet-bulb temperature	-10...+50°C	0...1VDC	temperature	-30...+70°C	0...1VDC

Accuracy of humidity in %rh at 23°C

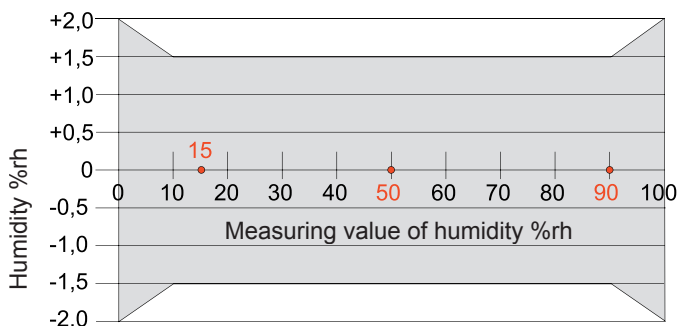

• Calibration values (humidity generator)

Load for 0(4)...20mA current version

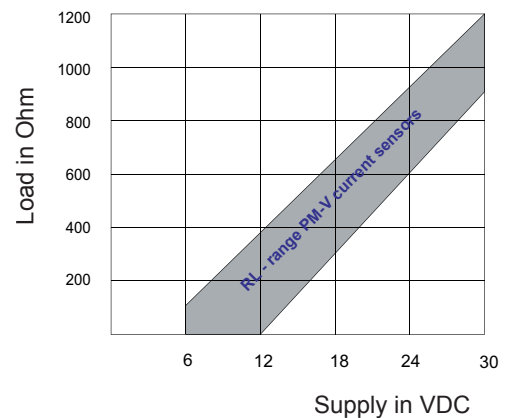

ESD protection advice

All PM15V sensors are made up of a PMO15V transmitter with a PMU-V sensor head and components which can be damaged by the effects of electrical fields or by charge equalisation when touched. This is why the PMU-V sensor heads, that can be supplied separately and that are suitable for being exchanged on location, are packaged in conductive, reusable ESD protected bags.

The following protective measures must be taken when exchanging a PMU-V sensor head on the PMO15V transmitter:

- Before unpacking the PMU-V sensor head, ensure electrical potential equalisation between you and your environment.
- Pay particular attention to ensuring that this potential equalisation is maintained while you are exchanging the PMU-V sensor head.
- Only store or transport the PMU-V sensor head in the ESD protective bag supplied, or in comparable packaging

Connection diagrams PM80V, PM100V

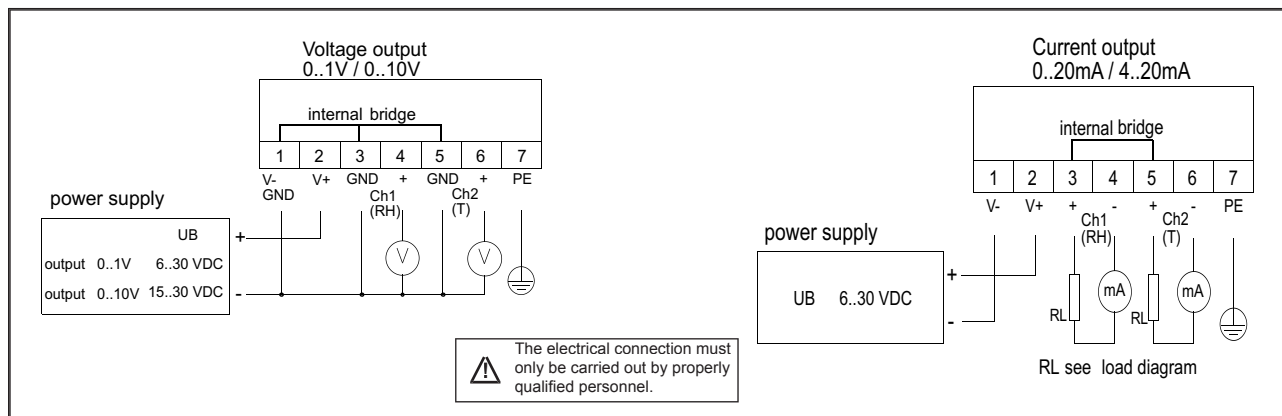

Shielding PM80V



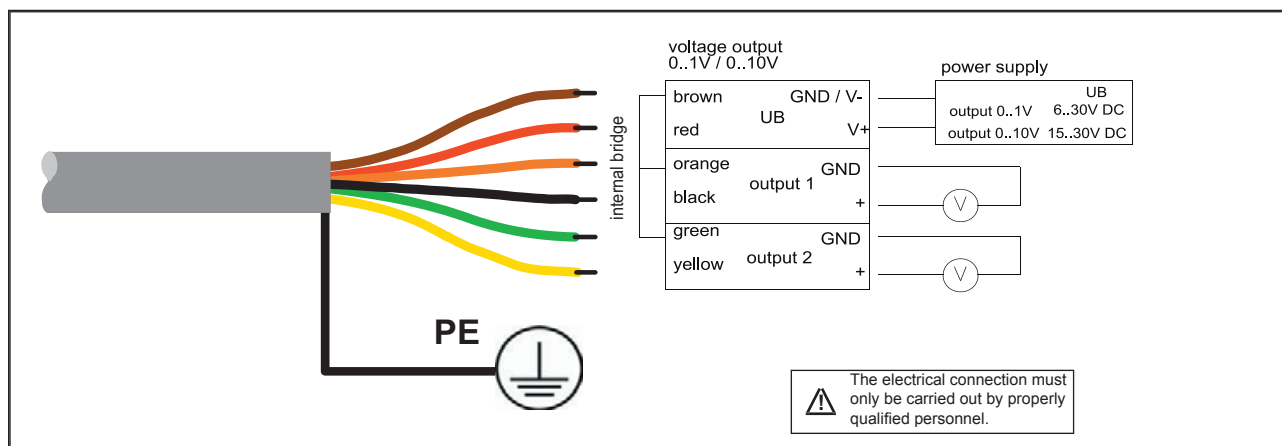

Please fix the shielding for PM80V (with alu housing) in the cable gland (see photo).

Connection diagram PM15V

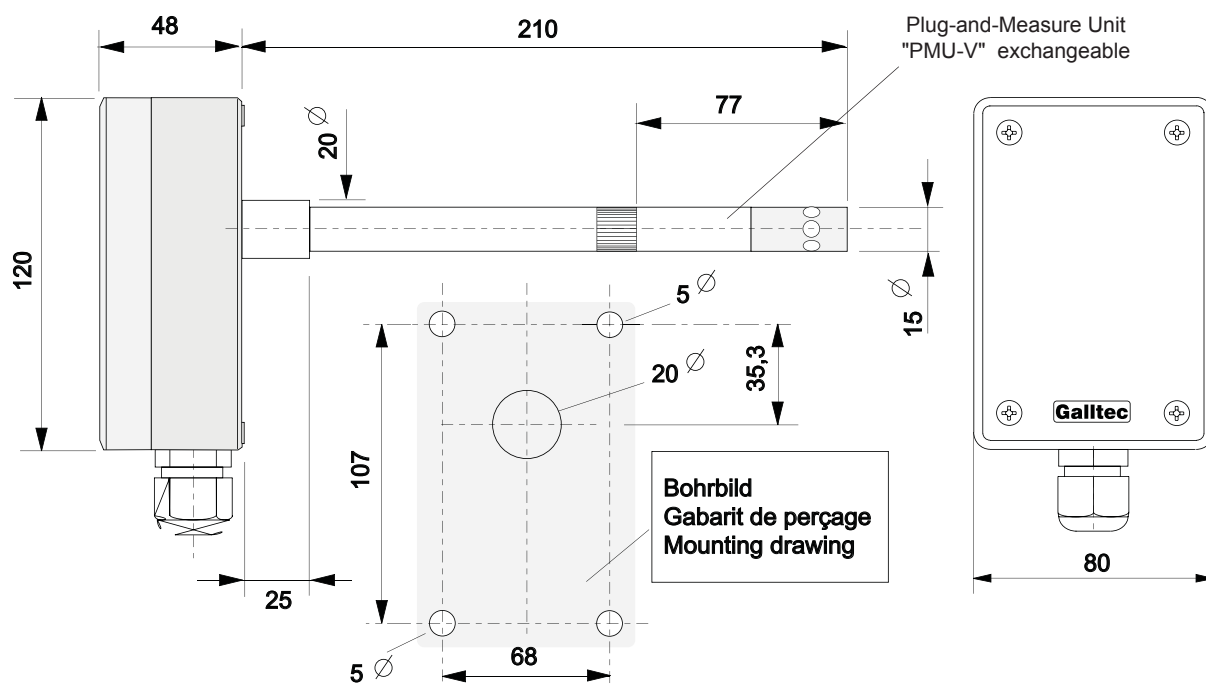

Humidity-Temperature Sensor PM100V
with plastic housing IP64



 The electrical connection must only be carried out by properly qualified personnel.

Humidity-Temperature Sensor PM80V
with housing made of aluminium die-casting IP65

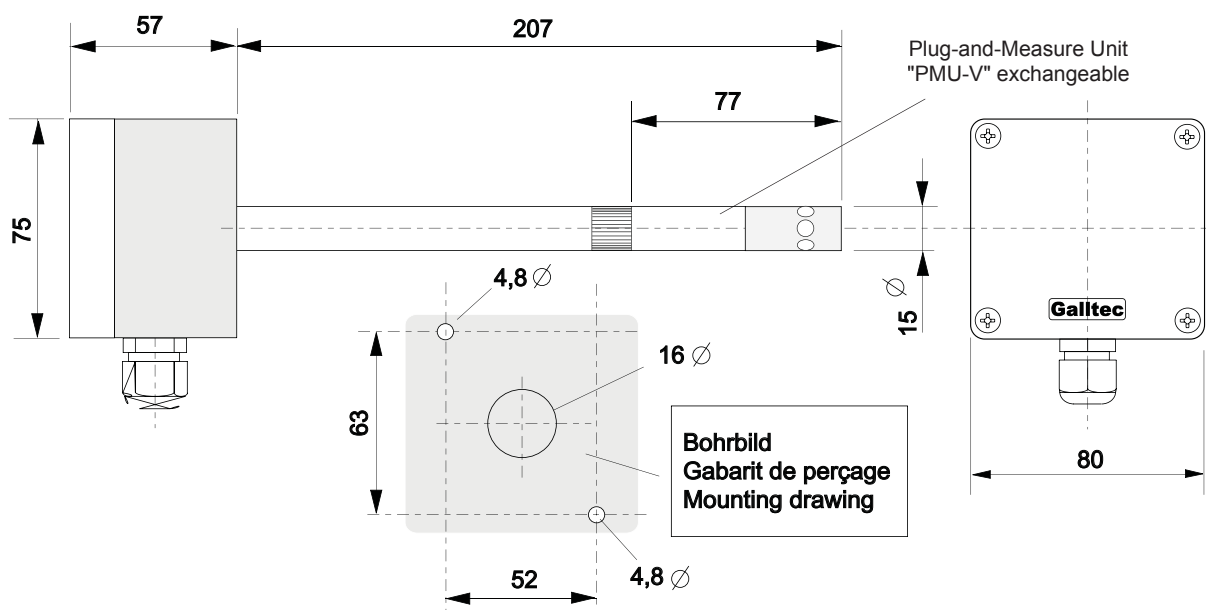

Humidity-Temperature Sensor PM15V
in cable version

